



Reference Guide to Fiber Optic Testing

Volume 1



Reference Guide to Fiber Optic Testing

Volume 1

By

J. Laferrière

G. Lietaert

R. Taws

S. Wolszczak

Contact the authors

JDSU

34 rue Necker

42000 Saint-Etienne

France

Tel. +33 (0) 4 77 47 89 00

Fax +33 (0) 4 77 47 89 70

Stay Informed

To be alerted by email to availability of newly published chapters to this guide, go to www.jdsu.com/fiberguide2



Copyright 2007, JDS Uniphase Corporation

All rights reserved. The information contained in this document is the property of JDSU. No part of this book may be reproduced or utilized in any form or means, electronic or mechanical, including photocopying, recording, or by any information storage and retrieval system, without permission in writing from the publisher.

JDSU shall not be liable for errors contained herein.

All terms mentioned in this book that are known to be trademarks or service marks have been appropriately indicated.



Table of Contents

- Chapter 1: Principles of Light Transmission on a Fiber** 1
- 1.1 **Optical Communications** 2
- 1.2 **Fiber Design** 3
- 1.3 **Transmission Principles** 4
 - 1.3.1 Light Propagation 5
 - 1.3.2 Velocity 6
 - 1.3.3 Bandwidth 7
- 1.4 **Types of Fiber** 8
 - 1.4.1 Multimode Fiber 9
 - 1.4.2 Singlemode Fiber 11
 - 1.4.3 Review of Singlemode and Multimode Fiber 15
- 1.5 **Light Transmission** 16
 - 1.5.1 Attenuation 16
 - 1.5.2 Dispersion 21
 - 1.5.3 Optical Return Loss 24
 - 1.5.4 Non-Linear Effects 27
 - 1.5.5 Summary of Transmission Effects 31
- 1.6 **Standards and Recommendations of Fiber Optic Systems** 32
 - 1.6.1 International Standards 32
 - 1.6.2 National Standards 33
 - 1.6.3 Fiber Optic Standards 34
 - 1.6.4 Test and Measurement Standards 34

- Chapter 2: Insertion Loss, Return Loss, Fiber Characterization, and Ancillary Test Kits** 37
- 2.1 **Optical Fiber Testing** 38
- 2.2 **Transmission Tests** 39



2.2.1	Measurement Units	39
2.2.2	Measurement Parameters	40
2.2.3	Field Testing	41
2.3	Optical Tester Families	43
2.3.1	Light Sources	43
2.3.2	Power Meters	44
2.3.3	Loss Test Sets	48
2.3.4	Attenuators	50
2.3.5	Optical Loss Budget	50
2.3.6	Optical Return Loss Meters	53
2.3.7	Mini-OTDR and Fault Locators	56
2.3.8	Fiber Characterization Testing	57
2.3.9	Other Test Tools	59
2.3.10	Monitoring Systems	62

Chapter 3: Optical Time Domain Reflectometry 65

3.1	Introduction to OTDR	66
3.2	Fiber Phenomena	67
3.2.1	Rayleigh Scattering and Backscattering	67
3.2.2	Fresnel Reflection and Backreflection	69
3.3	OTDR Technology	71
3.3.1	Emitting Diodes	72
3.3.2	Using a Pulse Generator with a Laser Diode	74
3.3.3	Photodiodes	75
3.3.4	Time Base and Control Unit	76
3.4	OTDR Specifications	78
3.4.1	Dynamic Range	78



3.4.2	Dead Zone	81
3.4.3	Resolution	85
3.4.4	Accuracy	86
3.4.5	Wavelength	87

Chapter 4: Using an Optical Time Domain Reflectometer (OTDR) 89

4.1	Introduction	90
4.2	Acquisition	91
4.2.1	Injection Level	91
4.2.2	OTDR Wavelength	92
4.2.3	Pulsewidth	96
4.2.4	Range	98
4.2.5	Averaging	98
4.2.6	Fiber Parameters	99
4.3	Measurement	101
4.3.1	Event Interpretation	101
4.3.2	OTDR Measurements	103
4.3.3	Measurement Methods	104
4.3.4	Slope	106
4.3.5	Event Loss	107
4.3.6	Reflectance	110
4.3.7	Optical Return Loss	111
4.4	Measurement Artifacts and Anomalies	114
4.4.1	Ghosts	114
4.4.2	Splice Gain	115
4.5	Bidirectional Analysis	118
4.5.1	Bidirectional Analysis of a Hypothetical Span	119



4.6	Getting the Most Out of Your OTDR	122
4.6.1	Using Launch Cables	122
4.6.2	Verifying Continuity	124
4.6.3	Fault Location	125
4.6.4	Effective Refractive Index	127
4.6.5	Automating Bidirectional Analysis	129
4.6.6	Loopback Measurement Method	130
4.7	OTDR Acceptance Reporting Tool	132
4.7.1	Results Analysis	132
4.7.2	Results Conditioning	134
4.7.3	Report Generation	136
4.7.4	Document Printout	136





Principles of Light Transmission on a Fiber

Chapter 1

1.1 Optical Communications

The principle of an optical communications system is to transmit a signal through an optical fiber to a distant receiver. The electrical signal is converted into the optical domain at the transmitter and is converted back into the original electrical signal at the receiver. Fiber optic communication has several advantages over other transmission methods, such as copper and radio communication systems.

- A signal can be sent over long distances (200 km) without the need for regeneration.
- The transmission is not sensitive to electromagnetic perturbations. In addition, the fiber does not conduct electricity and is practically insensitive to RF interferences.
- Fiber optic systems provide greater capacity than copper or coaxial cable systems.
- The fiber optic cable is much lighter and smaller than copper cable. Therefore, fiber optic cables can contain a large number of fibers in a much smaller area. For example, a single fiber cable can consist of 144 fibers.
- Optical fiber is reliable, is very flexible, and is not sensitive to vibrations.
- Optical fiber is guaranteed for 25 years (compared to a guarantee of 10 years for satellite communications systems).
- Operating temperatures for optical fiber varies, but they typically range from -40°C to $+80^{\circ}\text{C}$.

There are three main factors that can affect light transmission in an optical communication system.

1. Attenuation: As the light signal traverses the fiber, it will lose optical power due to absorption, scattering, and other radiation losses. At some point, the power level may become too weak for the receiver to distinguish between the optical signal and the background noise.

2. Bandwidth: Since the light signal is composed of different frequencies, the fiber will limit the highest and lowest frequencies and will limit the information carrying capacity.

3. Dispersion: As the light signal traverses the fiber, the light pulses will spread or broaden and will limit the information carrying capacity at very high bit rates or for transmission over very long distances.

1.2 Fiber Design

An optical fiber is composed of a very thin glass rod, which is surrounded by a plastic protective coating. The glass rod contains two parts, the inner portion of the rod (or core) and the surrounding layer (or cladding). Light, which is injected into the core of the glass fiber, will follow the physical path of that fiber due to the total internal reflection of the light between the core and the cladding.



The composition of optical fiber

1.3 Transmission Principles

A ray of light enters a fiber at a small angle α . The capability (maximum acceptable value) of the fiber cable to receive light through its core is determined by its numerical aperture (NA).

$$NA = \sin \alpha_0 = \sqrt{n_1^2 - n_2^2}$$

Where α_n is the maximum angle of acceptance (that is, the limit between reflection and refraction), n_1 is the core refractive index, and n_2 is the cladding refractive index.

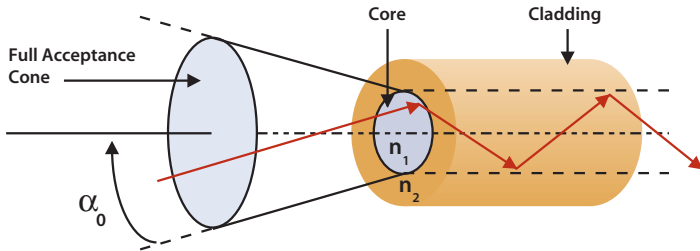

The injection of light into a fiber

The full acceptance cone is defined as $2\alpha_n$.

1.3.1 Light Propagation

The propagation of a ray of light in optical fiber follows Snell-Descartes' law. A portion of the light is guided through the optical fiber when injected into the fiber's full acceptance cone.

1.3.1.1 Refraction

Refraction is the bending of a ray of light at an interface between two dissimilar transmission media. If $\alpha > \alpha_0$, then the ray is fully refracted and is not captured by the core.

$$n_1 \sin \alpha_i = n_2 \sin \alpha_r$$

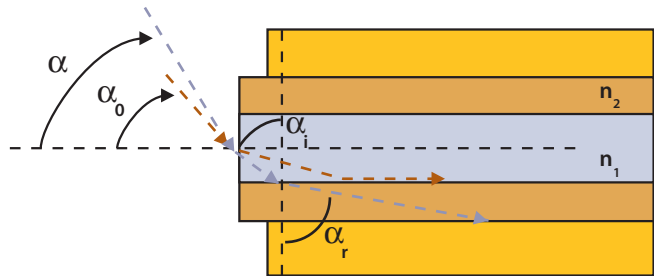

Refraction of light

1.3.1.2 Reflection

Reflection is the abrupt change in direction of a light ray at an interface between two dissimilar transmission media. In this case, the light ray returns to the media from which it originated. If $\alpha < \alpha_0$, then the ray is reflected and remains in the core.

$$\alpha_i = \alpha_r$$

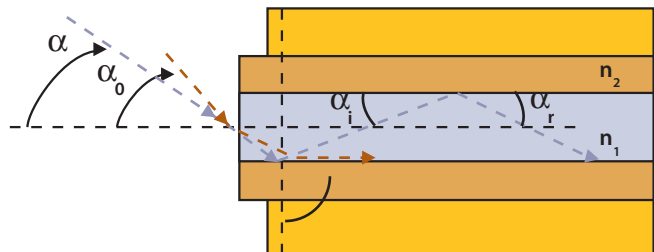

Reflection of light

1.3.1.3 Propagation Principle

Light rays enter the fiber at different angles and do not follow the same paths. Light rays entering the center of the fiber core at a very low angle will take a relatively direct path through the center of the fiber. Light rays entering the fiber core at a high angle of incidence or near the outer edge of the fiber core will take a less direct, longer path through the fiber and will traverse the fiber more slowly. Each path, resulting from a given angle of incidence and a given entry point, will give rise to a mode. As the modes travel along the fiber, each of them is attenuated to some degree.

1.3.2 Velocity

The velocity at which light travels through a transmission medium is determined by the refractive index of the transmission medium. The refractive index (n) is a unitless number, which represents the ratio of the velocity of light in a vacuum to the velocity of light in the transmission medium.

$$n = c/v$$

Where n is the refractive index of the transmission medium, c is the speed of light in a vacuum (2.99792458×10^8 m/s), and v is the speed of light in the transmission medium.

Typical values of n for glass (i.e. optical fiber) are between 1.45 and 1.55. As a rule of thumb, the higher the refractive index, the slower the speed in the transmission medium.

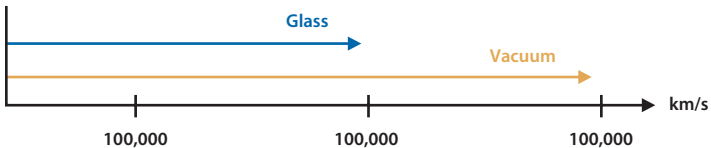

Comparing the speed of light through different transmission mediums

Typical manufacturer's values for Index of Refraction are:

- Corning LEAF
 - n=1.468 @1550 nm
 - n=1.469 @1625 nm
- OFS TrueWave Reach
 - n=1.471 @1310 nm
 - n=1.470 @1550 nm

1.3.3 Bandwidth

Bandwidth is defined as the width of the frequency range that can be transmitted by an optical fiber. The bandwidth determines the maximum transmitted information capacity of a channel, which can be carried along the fiber over a given distance. Bandwidth is expressed in MHz·km. In multimode fiber, bandwidth is mainly limited by modal dispersion; whereas there is almost no limitation for bandwidth in singlemode fiber.

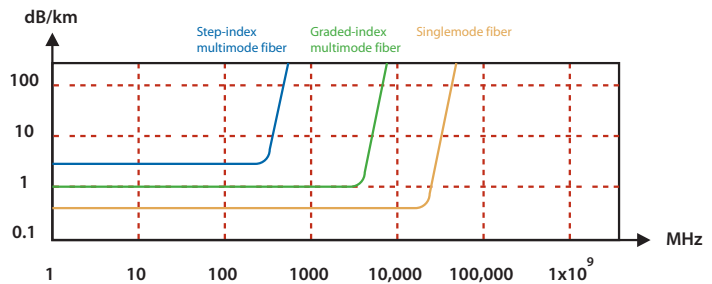

Typical bandwidths for different types of fiber

1.4 Types of Fiber

Fiber is classified into different types (multimode or singlemode) based on the way in which the light travels through it. The fiber type is closely related to the diameter of the core and cladding.

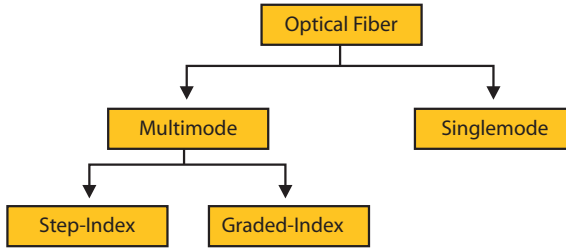

Types of glass fiber

Multimode fiber, due to its large core, allows for the transmission of light using different paths (multiple modes) along the link. For this reason, multimode fiber is quite sensitive to modal dispersion.

The primary advantages of multimode fiber are the ease of coupling to light sources and to other fiber, lower cost light sources (transmitters), and simplified connectorization and splicing processes. However, its relatively high attenuation and low bandwidth limit the transmission of light over multimode fiber to short distances.

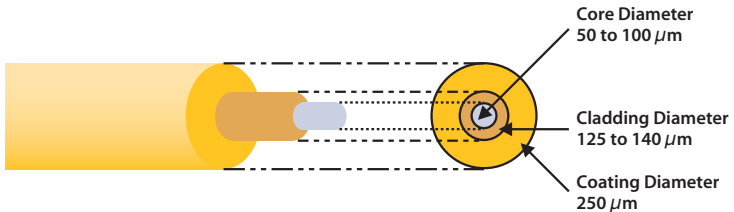

The composition of multimode fiber

1.4.1.1 Step-Index Multimode Fiber

Step-index (SI) multimode fiber guides light rays through total reflection on the boundary between the core and cladding. The refractive index is uniform in the core. Step-index multimode fiber has a minimum core diameter of $50\ \mu\text{m}$ or $62.5\ \mu\text{m}$, a cladding diameter between 100 and $140\ \mu\text{m}$, and a numerical aperture between 0.2 and 0.5 .

Due to modal dispersion, the drawback of step-index multimode fiber is its very low bandwidth, which is expressed as the bandwidth-length product in $\text{MHz}\cdot\text{km}$. A fiber bandwidth of $20\ \text{MHz}\cdot\text{km}$ indicates that the fiber is suitable for carrying a $20\ \text{MHz}$ signal for a distance of $1\ \text{km}$, a $10\ \text{MHz}$ signal for a distance of $2\ \text{km}$, a $40\ \text{MHz}$ signal for a distance of $0.5\ \text{km}$, etc.

Step-index multimode fiber is surrounded by a plastic coating and is used mostly for short distance links that can accommodate high attenuations.

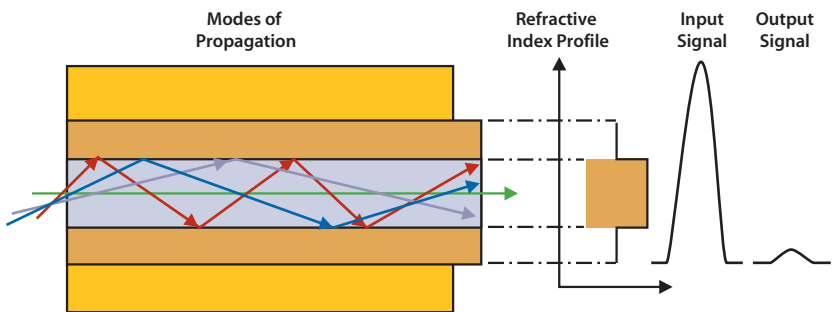

Light propagation through step-index multimode fiber

1.4.1.2 Graded-Index Multimode Fiber

The core of graded-index (GI) multimode fiber possesses a non-uniform refractive index, decreasing gradually from the central axis to the cladding. This index variation of the core forces the rays of light to progress through the fiber in a sinusoidal manner.

The highest order modes will have a longer path to travel, but outside of the central axis in areas of low index, their speeds will

increase. In addition, the difference in speed between the highest order modes and the lowest order modes will be smaller for graded-index multimode fiber than for step-index multimode fiber.

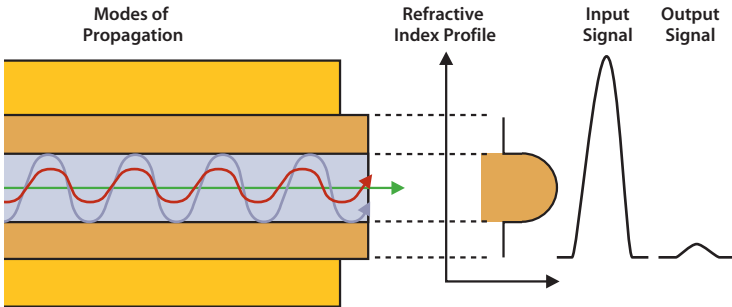

Light propagation through graded-index multimode fiber

Typical attenuations for graded-index multimode fiber:

- 3 dB/km at 850 nm
- 1 dB/km at 1300 nm

Typical numerical aperture for graded-index multimode fiber: 0.2

Typical bandwidth-length product for graded-index multimode fiber:

- 160 MHz·km at 850 nm
- 500 MHz·km at 1300 nm

Typical values for the refractive index:

- 1.49 for 62.5 μm at 850 nm
- 1.475 for 50 μm at 850 nm and 1.465 for 50 μm at 1300 nm

1.4.1.3 Types of Multimode Fiber

The ITU-T G.651 standard defines the characteristics of a 50/125 μm graded-index multimode optical fiber cable. The increased demand for bandwidth in multimode applications, including Gigabit Ethernet (GigE) and 10 GigE, has resulted in the definition of three different ISO categories.

Comparing the ISO categories of the ITU-T's G.651 standard

Standards	Characteristics	Wavelengths	Applications
G.651 ISO/IEC 11801:2002 (OM1)	Legacy graded-index multimode fiber	850 nm and 1300 nm	Data communications in access networks
G.651 ISO/IEC 11801:2002 (OM2)	Legacy graded-index multimode fiber	850 nm and 1300 nm	Video and Data communications in access networks
G.651 ISO/IEC 11801:2002 (OM3)	Laser optimized; graded-index multimode fiber; 50/125 μm maximum	Optimized for 850 nm	GigE and 10 GigE transmission in local area networks (up to 300 m)

1.4.2 Singlemode Fiber

The advantage of singlemode fiber is its higher performance with respect to bandwidth and attenuation. The reduced core diameter of singlemode fiber limits the light to only one mode of propagation, eliminating modal dispersion completely.

With proper dispersion compensating components, a singlemode fiber can carry signal of 10 Gbit/s, 40 Gbit/s and above over long distances. The system carrying capacity may be further increased by injecting multiple signals of slightly differing wavelengths (wavelength division multiplexing) into one fiber.

The small core size of singlemode fiber generally requires more expensive light sources and alignment systems to achieve efficient coupling. In addition, splicing and connectorization is also somewhat complicated. Nonetheless, for high performance systems or for systems that are more than a few kilometers in length, singlemode fiber remains the best solution.

The typical dimensions of singlemode fiber range from a core of 8 to 12 μm and a cladding of 125 μm . The typical core-cladding angle is 8.5°. The refractive index of singlemode fiber is typically 1.465.

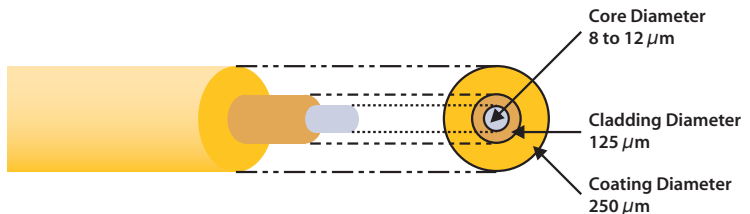

The composition of singlemode fiber

Since the small core diameter of singlemode fiber decreases the number of propagation modes, only one ray of light propagates down the core at a time.

1.4.2.1 Mode Field Diameter

The mode field diameter (MFD) of singlemode fiber can be expressed as the section of the fiber where the majority of the light energy passes.

The MFD is larger than the physical core diameter. That is, a fiber with a physical core of $8\ \mu\text{m}$ can yield a $9.5\ \mu\text{m}$ MFD. This phenomenon occurs because some of the light energy also travels through the cladding.

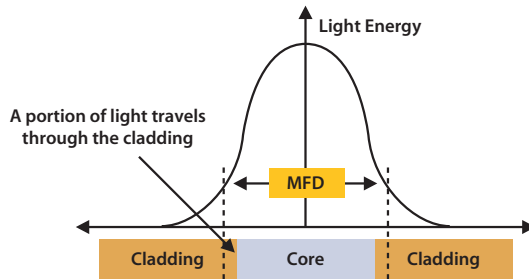

The mode field diameter (MFD) of singlemode fiber

Larger mode field diameters are less sensitive to lateral offset during splicing, but they are more sensitive to losses incurred by bending during either the installation or cabling processes.

Effective Area

Effective area is another term that is used to define the mode field diameter. The effective area is the area of the fiber corresponding to the mode field diameter.

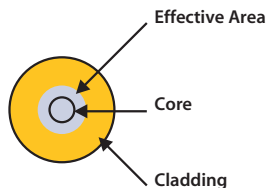

The effective area of singlemode fiber

The effective area (or mode field diameter) has a direct influence on non-linear effects, which depend directly on the power density of the light injected into the fiber. The higher the power density, the higher the incidence of non-linear effects.

The effective area of a fiber determines the power density of the light. For a given power level, a small effective area will provide a high power density. Subsequently, for a larger effective area, the power is better distributed, and the power density is less important. In other words, the smaller the effective area, the higher the incidence of non-linear effects.

The effective area of a standard singlemode fiber is approximately $80 \mu\text{m}^2$ and can be as low as $30 \mu\text{m}^2$ for compensating fiber. The effective area of a fiber is often included in the description of the fiber's name, such as Corning's LEAF (for large effective area fiber).

1.4.2.2 Types of Singlemode Fiber

There are different types of singlemode fiber, which are classified according to their attenuation range, chromatic dispersion (CD) values, and polarization mode dispersion (PMD) coefficients. The ITU-T has provided a set of standards in order to classify singlemode fiber.

G.652: Characteristics of singlemode optical fiber and cable

	Characteristics	Wavelength Coverage	Applications
G.652.A	Max PMD = 0.5 $\text{ps}/\sqrt{\text{km}}$	1310 nm and 1550 nm regions (O and C bands)	Supports applications such as those recommended in G.957 and G.691 up to STM-16, 10 Gb/s up to 40 km (Ethernet), and STM-256 for G.693.
G.652.B	Maximum attenuation specified at 1625 nm. Max PMD = 0.2 $\text{ps}/\sqrt{\text{km}}$	1310 nm, 1550 nm, and 1625 nm regions (O and C+L bands)	Supports some higher bit rate applications up to STM-64 in G.691 and G.692 and some STM-256 applications in G.693 and G.959.1. Depending on the application, chromatic dispersion accommodation may be necessary.
G.652.C	Maximum attenuation specified at 1383 nm (equal or lower than 1310 nm). Max PMD = 0.5 $\text{ps}/\sqrt{\text{km}}$	From O to C bands	Similar to G.652.A, but this standard allows for transmission in portions of an extended wavelength range from 1360 nm to 1530 nm. Suitable for CWDM systems.
G.652.D	Maximum attenuation specified from 1310 to 1625 nm. Maximum attenuation specified at 1383 nm (equal or lower than 1310 nm). Max PMD = 0.2 $\text{ps}/\sqrt{\text{km}}$	Wide band coverage (from O to L bands)	Similar to G.652.A, but this standard allows for transmission in portions of an extended wavelength range from 1360 nm to 1530 nm. Suitable for CWDM systems.

G.653: Characteristics of dispersion shifted singlemode optical fiber and cable

	Characteristics	Wavelength Coverage	Applications
G.653.A	Zero chromatic dispersion value at 1550 nm. Maximum attenuation of 0.35 dB/km at 1550 nm. Max PMD = 0.5 $\text{ps}/\sqrt{\text{km}}$	1550 nm	Supports high bit rate applications at 1550 nm over long distances.
G.653.B	Same as G.653.A, except: Max PMD = 0.2 $\text{ps}/\sqrt{\text{km}}$	1550 nm	Introduced in 2003 with a low PMD coefficient, this standard supports higher bit rate transmission applications than G.653.

G.655: Characteristics of non-zero dispersion shifted singlemode optical fiber and cable

	Characteristics	Wavelength Coverage	Applications
G.655.A	Maximum attenuation specified at 1550 nm only. Lower CD value than G.655.B and G.655.C. Max PMD = 0.5 $\text{ps}/\sqrt{\text{km}}$	C bands	Supports DWDM transmission (G.692) applications in the C bands with down to 200 GHz channel spacing.
G.655.B	Maximum attenuation specified at 1550 nm and 1625 nm. Higher CD value than G.655.A. Max PMD = 0.5 $\text{ps}/\sqrt{\text{km}}$	1550 nm and 1625 nm regions (C+L bands)	Supports DWDM transmission (G.692) applications in the C+L bands with down to 100 GHz channel spacing.
G.655.C	Maximum attenuation specified at 1550 nm and 1625 nm. Higher CD value than G.655.A. Max PMD = 0.2 $\text{ps}/\sqrt{\text{km}}$	From O to C bands	Similar to G.655.B, but this standard allows for transmission applications at high bit rates for STM-64/OC-192 (10 Gb/s) over longer distances. Also suitable for STM-256/OC-568 (40 Gb/s).

The recent G.656 standard (06/2004) is an extension of G.655, but it specifically addresses the wider wavelength range for transmission over the S, C, and L bands.

G.656: Characteristics of non-zero dispersion shifted fiber for wideband transport

	Characteristics	Wavelength Coverage	Applications
G.656	Maximum attenuation specified at 1460 nm, 1550 nm, and 1625 nm. Minimum CD value of 2 ps/nm.km between 1460 nm and 1625 nm. Max PMD = 0.2 ps/√km	S, C, and L bands	Supports both CWDM and DWDM systems throughout the wavelength range of 1460 nm and 1625 nm.

There are other types of fiber, such as polarization maintaining singlemode fiber and plastic fiber, which are outside the scope of this document.

1.4.3 Review of Singlemode and Multimode Fiber

The table below provides a quick comparison between multimode and singlemode fiber.

Review of singlemode and multimode fiber

	Multimode	Singlemode
Cost of fiber	Expensive	Less expensive
Transmission equipment	Basic and low cost (LED)	More expensive (laser diode)
Attenuation	High	Low
Transmission wavelengths	850 nm to 1300 nm	1260 nm to 1640 nm
Use	Larger core, easier to handle	Connections more complex
Distances	Local networks (<2 km)	Access/medium/long haul networks (>200 km)
Bandwidth	Limited bandwidth (10 Gb/s over short distances)	Nearly infinite bandwidth (>1 Tb/s for DWDM)
Conclusion	The fiber is more costly, but network deployment is relatively inexpensive.	Provides higher performance, but building the network is expensive.

1.5 Light Transmission

Light transmission in optical fiber uses three basic elements: a transmitter, a receiver, and a transmission medium by which the signal is passed from one to the other. The use of optical fiber introduces attenuation and dispersion into the system. Attenuation tends to increase the power requirements of the transmitter in order to meet the power requirements of the receiver. Dispersion, on the other hand, limits the bandwidth of the data that can be transmitted over the fiber.

1.5.1 Attenuation

As the light signal traverses the fiber, it decreases in power level. The decrease in power level is expressed in dB or as a rate of loss per unit distance (dB/km)

1.5.1.1 Fiber Spectral Attenuation

The two main loss mechanisms of light transmission in optical fiber are light absorption and scattering.

Light Absorption

Light is absorbed in the fiber material as its energy is converted to heat due to molecular resonance and wavelength impurities. For example, hydrogen and hydroxide resonance occurs at approximately 1244 nm and 1383 nm.

Rayleigh Scattering

Scattering, primarily Rayleigh scattering, also contributes to attenuation. Scattering causes dispersion of the the light energy in all directions, with some of the light escaping the fiber core. A small portion of this light energy is returned down the core and is termed *backscattering*.

Forward light scattering (Raman scattering) and backward light scattering (Brillouin scattering) are two additional scattering phenomena that can occur in optical materials under high power conditions.



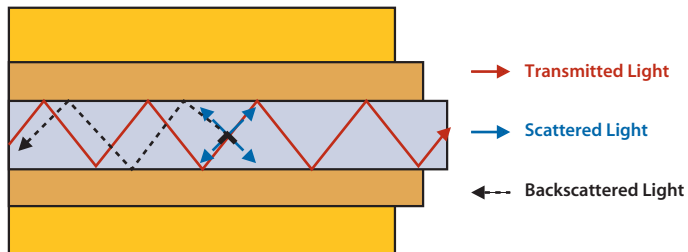

Backscattering effects of light transmission

Attenuation depends on the fiber type and the wavelength. For example, Rayleigh scattering is inversely proportional to the fourth power of the wavelength. If the absorption spectrum of a fiber is plotted against the wavelength of the laser, certain characteristics of the fiber can be identified. The following graph illustrates the relationship between the wavelength of the injected light and the total fiber attenuation.

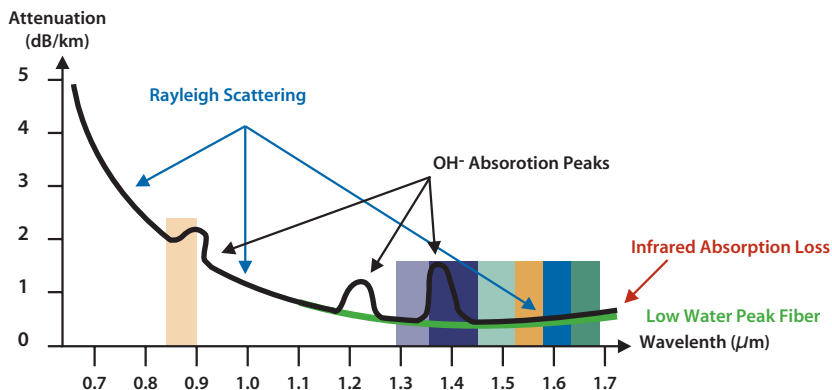

Fiber attenuation as a function of wavelength

The main telecommunication transmission wavelengths correspond to the points on the graph where attenuation is at a minimum. These wavelengths are known as the *telecom windows*. The ITU-T's G.692 standard has defined additional windows, called bands, which are dedicated to DWDM transmission systems.

■ 820-880 nm (1st window)	■ S Band 1460-1530 nm
■ O Band 1260-1360 nm (2nd window)	■ C Band 1530-1565 nm (3rd window)
■ E Band 1360-1460 nm	■ L Band 1565-1625 nm
	■ U Band 1625-1675 nm

The OH⁻ symbol identified in the graph indicates that at the wavelengths of 950 nm, 1244 nm, and 1383 nm, the presence of hydrogen and hydroxide ions in the fiber optic cable material causes an increase in attenuation. These ions result from the presence of water that enters the cable material through either a chemical reaction in the manufacturing process or as humidity in the environment. The variation of attenuation with wavelength due to the water peak for standard singlemode fiber optic cable occurs mainly around 1383 nm. Recent advances in the manufacturing processes of fiber optic cable have overcome the 1383 nm water peak and have resulted in *low water peak* fiber. Examples of this type of fiber include SMF-28e from Corning and OFS AllWave from Lucent.

1.5.1.2 Link Loss Mechanisms

For a fiber optic span, the effects of passive components and connection losses must be added to the inherent attenuation of the fiber in order to obtain the total signal attenuation. This attenuation (or loss), for a given wavelength, is defined as the ratio between the input power and the output power of the fiber being measured. It is generally expressed in decibels (dB).

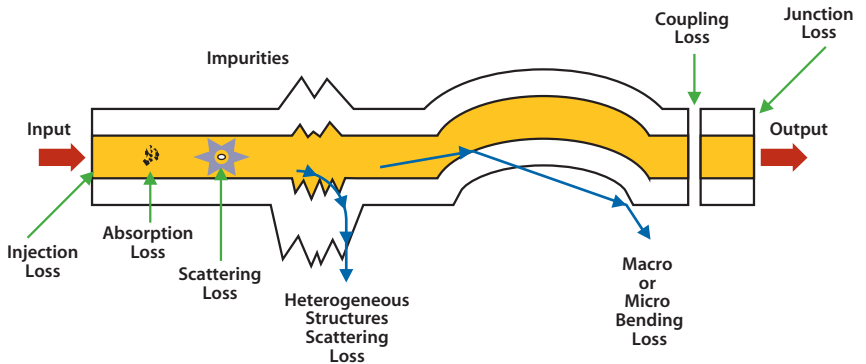

Link loss mechanisms

1.5.1.3 Micro Bends and Macro Bends

Micro bends and macro bends are common problems in installed cable systems because they can induce signal power loss.

Micro bending occurs when the fiber core deviates from the axis and can be caused by manufacturing defects, mechanical constraints during the fiber laying process, and environmental variations (temperature, humidity, or pressure) during the fiber's lifetime.

Macro bending refers to a large bend in the fiber (with more than a 2 mm radius). The graph below shows the influence of the bend radius (R) on signal loss as a function of the wavelength. The trace “ μc ” refers to an ideal fiber with no bending.

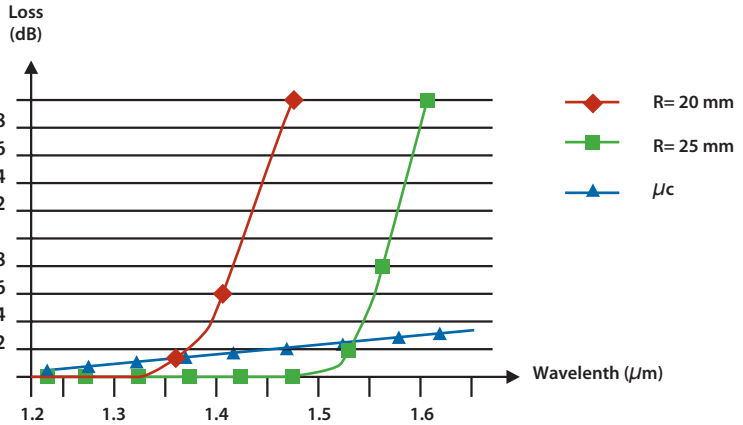

The effects of macro bending on a fiber

For example, the signal loss for a fiber that has a 25 mm macro bend radius will be 2 dB at 1625 nm, but only 0.4 dB at 1550 nm.

Another way of calculating the signal loss is to add the typical fiber attenuation coefficient (according to the specific wavelength as indicated below) to the bending loss.

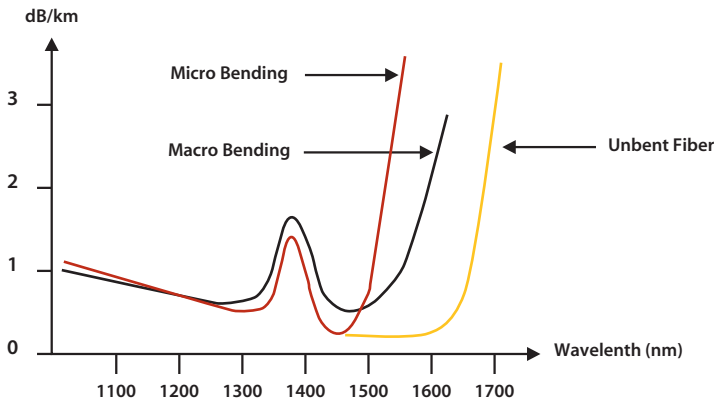

Typical attenuation coefficients for bent and unbent fiber

As shown in the above graph, if the L band (1565-1625 nm) or the U band (1625-1675 nm) are utilized, then loss testing is necessary at transmission wavelengths up to the upper limit of the band. For this reason, new test equipment has been developed with 1625 nm testing capabilities. Since the most important fiber parameters for network installation are splice loss, link loss, and optical return loss (ORL), it is necessary to acquire and use the appropriate test equipment.

1.5.2 Dispersion

Another factor that affects the signal during transmission is dispersion. Dispersion reduces the effective bandwidth available for transmission. There are three main types of dispersion: modal dispersion, chromatic dispersion, and polarization mode dispersion.

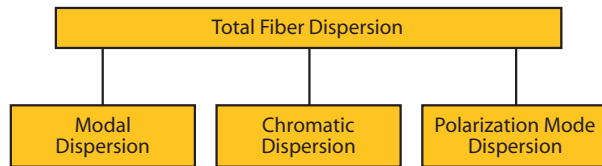

Types of fiber dispersion

1.5.2.1 Modal Dispersion

Modal dispersion typically occurs with multimode fiber. When a very short light pulse is injected into the fiber within the numerical aperture, all of the energy does not reach the end of the fiber at the same time. Different modes of oscillation carry the energy down the fiber using paths of differing lengths. For example, multimode fiber with a 50 μm core may have several hundred modes. This pulse spreading by virtue of different light path lengths is called modal dispersion, or more simply, multimode dispersion.

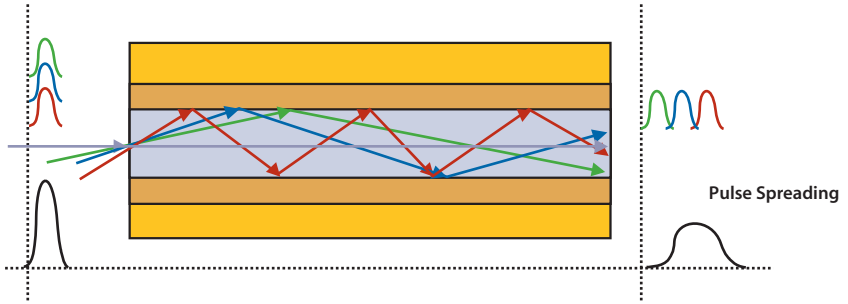

Modal dispersion in step-index multimode fiber

1.5.2.2 Chromatic Dispersion

Chromatic dispersion (CD) occurs because a light pulse is made up of different wavelengths, each traveling at different speeds down the fiber. These different propagation speeds broaden the light pulse when it arrives at the receiver, reducing the signal-to-noise ratio and increasing bit errors.

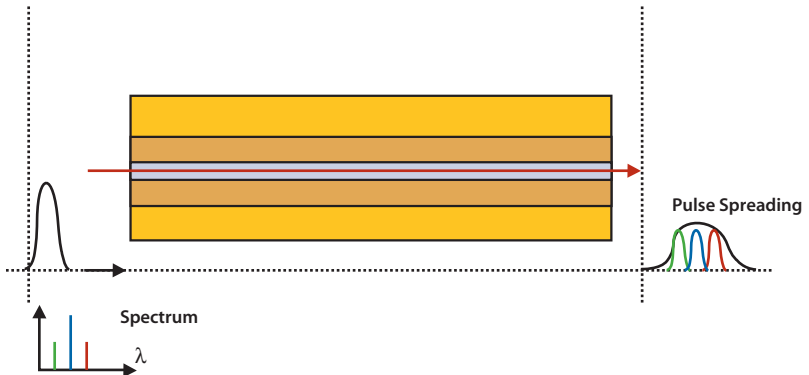

Chromatic dispersion caused by different wavelengths in a light source

Chromatic dispersion is defined by three principal parameters:

1. Delay at a given wavelength expressed in ps.
2. The coefficient of dispersion (D) expressed in ps/nm. This corresponds to the drift in delay as a function of wavelength (or to the slope of the curve representing delay as a function of distance at a given wavelength). It is expressed in ps/(nm · km) if it is standardized to one kilometer.
3. The slope (S) expressed in ps/(nm² · km). This corresponds to the drift in the coefficient of dispersion as a function of wavelength (or to the slope of the curve representing dispersion as a function of distance at a given wavelength).

Both the coefficient of dispersion (standardized to one kilometer) and the slope are dependent on the length of the fiber.

Chromatic dispersion primarily depends on the manufacturing process. Cable manufacturers take into account the effects of CD when designing different types of fiber for different applications and different needs, such as standard fiber, dispersion shifted fiber, or non-zero dispersion shifted fiber.

1.5.2.3 Polarization Mode Dispersion

Polarization mode dispersion (PMD) is a basic property of singlemode fiber. It affects the magnitude of the transmission rate. PMD results from the difference in propagation speeds of the energy of a given wavelength, which is split into two polarization axes that are at right angles to each other (as shown in the diagram below). The main causes of PMD are non-circularities of the fiber design and externally applied stresses on the fiber (macro bending, micro bending, twisting, and temperature variations).



Polarization mode dispersion (or differential group delay) effects on a fiber

The PMD is also referred to as the mean value of all differential group delays (DGD) and is expressed in picoseconds (ps). It can also be stated as the PMD coefficient, which is related to the square root of the distance and is expressed in $\text{ps}/\sqrt{\text{km}}$.

The PMD (mean DGD) causes the transmission pulse to broaden when it is transmitted along the fiber. This phenomenon generates distortion, increasing the bit error rate (BER) of the optical system. The consequence of PMD is that it limits the transmission bit rate on a link. Therefore, it is important to know the PMD value of the fiber in order to calculate the bit rate limits of the fiber optic link.

1.5.3 Optical Return Loss

1.5.3.1 Definition

Optical return loss (ORL) represents the total accumulated light power reflected back to the source from the complete optical span. This includes the backscattering light from the fiber itself, as well as the reflected light from all of the joints and terminations.

ORL is expressed in decibels (dB) and is defined as the logarithmic ratio of the incident power to the reflected power at the fiber origin.

$$\text{ORL} = 10 \text{Log} \frac{P_e}{P_r} \quad (\geq 0)$$

Where P_e is the emitted power and P_r the reflected power, expressed in Watt (W)

A high level of ORL will decrease the performance of some transmission systems. For example, high backreflection can dramatically affect the quality of an analog video signal, resulting in the degradation of the video image quality.

The higher the ORL value, the lower the reflected power; and subsequently, the smaller the effect of the reflection. Therefore, an ORL value of 40 dB is more desirable than an ORL value of 30 dB. It is important to note that ORL is expressed as a positive decibel value whereas the reflectance of a connector is expressed as negative value.

1.5.3.2 The Distance or Attenuation Effect

The total ORL value is affected by both the reflectance value of the event as well as its distance from the transmitter terminal.

As the length of the fiber increases, the amount of total backscattered light by the fiber also increases, and the fiber end reflection decreases. Therefore, for a short fiber link without intermediate reflective events, fiber end reflection is the predominate contribution to the total ORL since the amount of reflected light is not highly attenuated by the fiber.

On the other hand, end reflection of a long fiber length or a highly attenuated link is attenuated by absorption and scatter effects. In this case, the backscattered light becomes the major contribution to the total ORL, limiting the effect of end reflection.

The following graph shows the total ORL (reflectance and backscatter) for both terminated fiber (with no end reflection) and non-terminated fiber (with a glass-to-air backreflection of 4% or -14 dB). For distances shorter than 40 km, the difference in ORL between the terminated and non-terminated fiber is significant. But for longer distances (higher losses), the total ORL is almost equivalent.

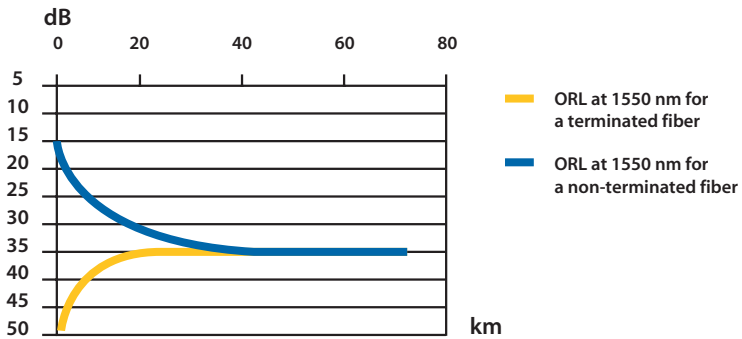

ORL as a function of distance at 1550 nm for terminated and non-terminated fiber

The importance of reflective events on total ORL depends, not only on their location along the fiber link, but also on the distance between the reflection and the active transmission equipment.

1.5.3.3 Effects of High ORL Values

If the ORL value is too high (low dB value), then light can resonate in the cavity of the laser diode, causing instability. There are several different effects that can result from high ORL values.

- An increase in transmitter noise that reduces optical signal to noise ratio (OSNR) in analog video transmission (CATV) systems and increases BER in digital transmission systems
- An increase in light source interference that changes the laser's central wavelength and varies the output power
- A higher incidence of transmitter damage

There are available solutions that will allow for a reduction in the ORL value or will limit the undesirable effects associated with a high ORL value. These solutions include:

- The use of low-reflection connectors, such as 8° angled polished contacts (APC), high return loss (HRL) connectors, or Ultra polished contacts (UPC)
- The use of optical isolators near the laser in order to reduce back reflection levels

1.5.4 Non-Linear Effects

Non-linear effects are mainly caused by the high power level and small effective area of the fiber. With an increase in the power level and the number of optical channels, non-linear effects can become problematic factors in transmission systems. These analog effects can be divided into two categories.

1. Refractive index phenomena: Causes phase modulation by variation in the refractive indexes
 - Self phase modulation (SPM)
 - Cross phase modulation (XPM)
 - Four wave mixing (FWM)
2. Stimulated scattering phenomena: Leads to power loss
 - Stimulated Raman scattering (SRS)
 - Stimulated Brillouin scattering (SBS)

1.5.4.1 Refractive Index Phenomena

Non-linear effects are dependent upon the non-linear portion of the refractive index n and cause the refractive index to increase for high signal power levels. Behind an EDFA, the high output can create non-linear effects, such as four wave mixing (FWM), self phase modulation (SPM), and cross phase modulation (XPM).

Four Wave Mixing

Four wave mixing (FWM) is an interference phenomenon that produces unwanted signals from three signal frequencies ($\lambda_{123} = \lambda_1 + \lambda_2 - \lambda_3$) known as ghost channels. Because three different channels induce a fourth channel, this phenomenon is referred to as four wave mixing.

There are a number of ways in which channels can combine to form a new channel according to the above formula. In addition, it should be noted that just two channels alone are also capable of inducing a third channel.

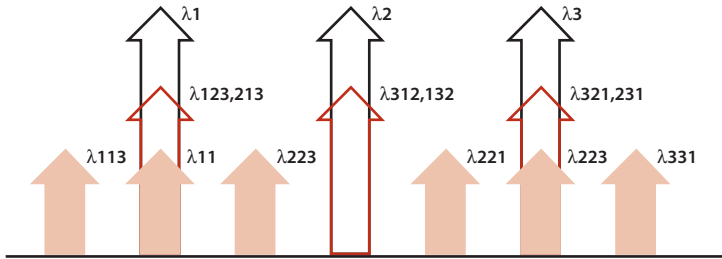

Four wave mixing of a signal on a fiber

Due to high power levels, FWM effects produce a number of ghost channels (some of which overlap actual signal channels), depending on the number of actual signal channels. For example, a 4-channel system will produce 24 unwanted ghost channels and a 16-channel system will produce 1920 unwanted ghost channels. Therefore, FWM is one of the most adverse non-linear effects in DWDM systems.

In systems using dispersion shifted fiber, FWM becomes a tremendous problem when transmitting around 1550 nm, the zero dispersion wavelength. Different wavelengths traveling at the same speed, or group velocity, and at a constant phase over a long period of time will increase the effects of FWM. In standard fiber (non-dispersion shifted fiber), a certain amount of chromatic dispersion occurs around 1550 nm, leading to different wavelengths having different group velocities. This results in a reduction of FWM effects. A reduction of FWM effects can also be achieved using irregular channel spacing.

Self Phase Modulation

Self phase modulation (SPM) is the effect that a signal has on its own phase, resulting in signal spreading. With high signal intensities, the light itself induces local variable changes in the refractive index of the fiber. This is known as the Kerr effect. This phenomenon produces a time-varying phase in the same channel. The time-varying refractive index modulates the phase of the

transmitted wavelength(s), broadening the wavelength spectrum of the transmitted optical pulse.

$$\Delta\phi = \frac{2\pi}{\lambda} \times \frac{L}{S \times P}$$

Where L is the link distance, S is the fiber section, and P is the optical power.

The result is a shift toward shorter wavelengths at the trailing edge of the signal (blue shift) as well as a shift toward longer wavelengths at the leading edge of the signal (red shift).

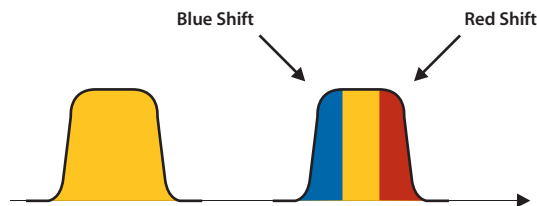

Self phase modulation of a signal on a fiber

The wavelength shifts caused by SPM are the exact opposite of positive chromatic dispersion. In advanced network designs, SPM can be used to partly compensate for the effects of chromatic dispersion.

Cross Phase Modulation

Cross phase modulation (XPM) is the effect that a signal in one channel has on the phase of another signal. Similar to SPM, XPM occurs as a result of the Kerr effect. XPM effects only arise, though, when multiple channels are transmitted on the same fiber. In XPM, the same frequency shifts at the edges of the signal in the modulated channel occur as in SPM, spectrally broadening the signal pulse.

1.5.4.2 Scattering Phenomena

Scattering phenomena can be categorized according to the processes that occur when the laser signal is scattered by fiber molecular vibrations (optical photons) or by induced virtual grating.

Stimulated Raman Scattering

Stimulated Raman scattering (SRS) is an effect that transfers power from a signal at a shorter wavelength to a signal at a longer wavelength. SRS is caused by the interaction of signal light waves with vibrating molecules (optical photons) within the silica fiber. Light is then scattered in all directions. Wavelength differences between two signals of about 100 nm (13.2 THz), 1550 nm to 1650 nm for example, show maximum SRS effects.

Stimulated Brillouin Scattering

Stimulated Brillouin scattering (SBS) is a backscattering phenomenon that causes loss of power. With high power signals, the light waves induce periodic changes in the refractive index of the fiber. This can be described as induced virtual grating, which travels away from the signal as an acoustic wave. The signal itself is then scattered, but it is mostly reflected off this induced virtual grating. SBS effects occur when only a few channels are transmitted.

1.5.5 Summary of Transmission Effects

The table below summarizes the different fiber transmission phenomenon and their associated impairments in optical telecommunication systems.

Summary of transmission effects

Impairment	Causes	Critical Power per Channel	Effects	Compensation
Attenuation	Material absorption/system		<ul style="list-style-type: none"> – Reduced signal power levels – Increased bit errors 	Shorter spans; purer fiber material
Chromatic Dispersion (CD)	Wavelength-dependent group velocity		<ul style="list-style-type: none"> – Increased bit errors 	Use of compensation fiber or modules (DCF/DCM)
Polarization Mode Dispersion (PMD)	Polarization state-dependent differential group delay		<ul style="list-style-type: none"> – Increased bit errors 	New fiber with low PMD values; careful fiber laying; PMD compensators
Four Wave Mixing (FWM)	Signal interference	10 mW	<ul style="list-style-type: none"> – Power transfer from original signal to other frequencies – Production of sidebands (harmonics) – Channel crosstalk – Increased bit errors 	Use of fiber with CD compensators; unequal channel spacing
Self Phase Modulation (SPM) and Cross Phase Modulation (XPM)	Intensity-dependent refractive index	10 mW	<ul style="list-style-type: none"> – Spectral broadening – Initial pulse compression (in positive CD regimes) – Accelerated pulse broadening (in negative CD regimes) – Channel crosstalk due to "walk-off" effects – Increased bit errors 	Use of fiber with CD compensators
Stimulated Raman Scattering (SRS)	Interaction of signal with fiber molecular structure	1 mW	<ul style="list-style-type: none"> – Decreased peak power – Decreased OSNR – Optical crosstalk (especially in bi-directional WDM systems) – Increased bit errors 	Careful power design
Stimulated Brillouin Scattering (SBS)	Interaction of signal with acoustic waves	5 mW	<ul style="list-style-type: none"> – Signal instability – Decreased peak power – Decreased OSNR – Optical crosstalk (especially in bi-directional WDM systems) – Increased bit errors 	Spectral broadening of the light source

1.6 Standards and Recommendations for Fiber Optic Systems

There are many international and national standards governing optical cable characteristics and measurement methods. Some are listed below, but the list is not exhaustive. Releases are subject to change.

1.6.1 International Standards

There are two main groups working on international standards: the International Electrotechnical Commission and the International Telecommunication Union.

1.6.1.1 International Electrotechnical Commission

The International Electrotechnical Commission (IEC) is a global organization that prepares and publishes international standards for all electrical, electronic, and related technologies. These standards serve as a basis for national standardization.

The IEC is composed of technical committees who prepare technical documents on specific subjects within the scope of an application, in order to define the related standards. For example, the technical committee TC86 is dedicated to fiber optics, and its sub-committees SC86A, SC86B, and SC86C focus on specific subjects such as:

- SC86A: Fibers and Cables
 - SC86B: Fiber Optic Interconnecting Devices and Passive Components
 - SC86C: Fiber Optic Systems and Active Devices
-
- 

1.6.1.2 International Telecommunication Union

The International Telecommunication Union (ITU) is an international organization that defines guidelines, technical characteristics, and specifications of telecommunications systems, networks, and services. It includes optical fiber performance and test and measurement applications. The ITU consists of three different sectors:

- Radiocommunication Sector (ITU-R)
- Telecommunication Standardization Sector (ITU-T)
- Telecommunication Development Sector (ITU-D)

1.6.2 National Standards

1.6.2.1 European Telecommunications Standards Institute

The European Telecommunications Standards Institute (ETSI) defines telecommunications standards. ETSI is responsible for the standardization of Information and Communication Technologies (ICT) within Europe. These technologies include telecommunications, broadcasting, and their related technologies, such as intelligent transportation and medical electronics.

1.6.2.2 Telecommunication Industries Association/Electronic Industries Alliance

The Telecommunication Industries Association/ Electronic Industries Alliance (TIA/EIA) provides additional recommendations for the United States. TIA is accredited by the American National Standards Institute (ANSI) to develop industry standards for a wide variety of telecommunications products. The committees and subcommittees define standards for fiber optics, user premises equipment, network equipment, wireless communications, and satellite communications.

It is important to note that many other standard organizations exist in other countries.

1.6.3 Fiber Optic Standards

- IEC 60793-1 and -2: Optical fibers (includes several parts)
- IEC 60794-1, -2, and -3: Optical fiber cables
- G.651: Characteristics of 50/125 μm multimode graded-index optical fiber
- G.652: Characteristics of singlemode optical fiber and cable
- G.653: Characteristics of singlemode dispersion shifted optical fiber and cable
- G.654: Characteristics of cut-off shifted singlemode optical fiber and cable
- G.655: Characteristics of non-zero dispersion shifted singlemode optical fiber and cable
- G.656: Characteristics of non-zero dispersion shifted fiber for wideband transport

1.6.4 Test and Measurement Standards

1.6.4.1 Generic Test Standards

- IEC 61350: Power meter calibration
- IEC 61746: OTDR calibration
- G.650.1: Definition and test methods for linear, deterministic attributes of singlemode fiber and cable
- G.650.2: Definition and test methods for statistical and non-linear attributes of singlemode fiber and cable

1.6.4.2 PMD Test Standards

- G.650.2: Definition and test methods for statistical and non-linear attributes of singlemode fiber and cable
- IEC 60793 1-48: Optical fibers - Part 1-48: Measurement methods and test procedures - polarization mode dispersion

-
- IEC/TS 61941: Technical specifications for polarization mode dispersion measurement techniques for singlemode optical fiber
 - TIA/EIA-455 FOTP-124A: Polarization mode dispersion measurement for singlemode optical fiber and cable assemblies by interferometry
 - TIA/EIA-455 FOTP-113: Polarization mode dispersion measurement of singlemode optical fiber by the fixed analyzer method
 - TIA/EIA-455 FOTP-122A: Polarization mode dispersion measurement for singlemode optical fiber by the Stokes parameter method
 - TIA/EIA TSB-107: Guidelines for the statistical specification of polarization mode dispersion on optical fiber cables
 - TIA/EIA 455-196: Guidelines for polarization mode measurements in singlemode fiber optic components and devices
 - GR-2947-CORE: Generic requirements for portable polarization mode dispersion (PMD) test sets
 - IEC-61280-4-4: Polarization mode dispersion measurement for installed links

1.6.4.3 CD Test Standards

- G.650.1: Definition and test methods for linear, deterministic attributes of singlemode fiber and cable
 - IEC 60793 1-42: Optical fibers - Part 1-42: Measurement methods and test procedures - chromatic dispersion
 - IEC 61744: Calibration of fiber optic chromatic dispersion test sets
 - TIA/EIA FOTP-168: Chromatic dispersion measurement of multimode graded index and singlemode optical fibers by spectral group delay measurement in the time domain
 - TIA/EIA FOTP-169: Chromatic dispersion measurement of singlemode optical fibers by the phase-shift method
-

-
- TIA/EIA FOTP-175: Chromatic dispersion measurement of singlemode optical fibers by the differential phase-shift method
 - GR-761-CORE: Generic criteria for chromatic dispersion test sets
 - GR-2854-CORE: Generic requirements for fiber optic dispersion compensators



Insertion Loss, Return Loss, Fiber Characterization, and Ancillary Test Kits

Chapter 2

2.1 Optical Fiber Testing

When analyzing a fiber optic cable over its product lifetime, a series of measurements must be performed in order to ensure its integrity.

- Mechanical tests
- Geometrical tests
- Optical tests
- Transmission tests

The first three sets of measurements are only performed once since there is minor variation in these parameters during the fiber's lifetime. Several measurements are performed on optical fiber or cables in order to characterize them before their use in signal transmission. Many of these measurements are described in the Fiber Optic Test Procedure (FOTP) propositions of the Electronic Industries Association (EIA) and are defined in the ITU-T's G650 recommendations or in the EN 188 000 document.

Optical fiber testing

Mechanical Tests	Geometrical Tests	Optical Tests	Transmission Tests
Traction	Concentricity	Index profile	Bandwidth
Torsion	Cylindricity	Numerical aperture	Optical power
Bending	Core diameter	Spot size	Optical loss
Temperature	Cladding diameter		Optical return loss
			Reflectometry
			Chromatic dispersion
			Polarization mode dispersion
			Attenuation profile

2.2 Transmission Tests

2.2.1 Measurement Units

The decibel (dB) is often used to quantify the gain or loss of optical power for fiber or network elements. The number of decibels is equivalent to ten times the logarithm of the power variation, which is the ratio between two power levels (expressed in Watts).

$$\text{dB} = 10 \text{ Log } \frac{P_1}{P_2}$$

The decibel is also often used in the context of transmitted signals and noise (lasers or amplifiers). Some of the most frequently used specifications include:

- dBm is the number of dB relative to a reference power of 1 mW. This is often used to specify absolute power levels. Therefore, the equation above becomes:

$$P(\text{dBm}) = 10 \text{ Log } \frac{P_1}{1\text{mW}}$$

Where P_1 is expressed in mW.

- dBc is the number of dB relative to a carrier. This term is used to specify the power of a sideband in a modulated signal relative to the carrier. For example, -30 dBc indicates that the sideband is 30 dB below the carrier.
- dBm is the number of dB relative to a reference level. This term is used to specify the power variation according to a reference power level.

Power loss can then be calculated as the difference between two power levels (output and input) expressed in dB.

$$\text{Loss(dB)} = P_{\text{out}} - P_{\text{in}}$$

The table below provides a set of absolute power levels converted from Watts to dBm.

Comparing absolute power levels in Watts and dBm

Absolute Power (W)	Absolute Power (dBm)
1 W	+30 dBm
100 mW	+20 dBm
10 mW	+10 dBm
5 mW	+7 dBm
1 mW	0 dBm
500 μ W	-3 dBm
100 μ W	-10 dBm
10 μ W	-20 dBm
1 μ W	-30 dBm
100 nW	-40 dBm

The table below provides the relationship between dB and power loss in terms of a percentage.

Comparing loss (dB) and the percentage of power loss

Loss (dB)	Power Loss (%)
-0.10 dB	2%
-0.20 dB	5%
-0.35 dB	8%
-1 dB	20%
-3 dB	50%
-6 dB	75%
-10 dB	90%
-20 dB	99%

2.2.2 Measurement Parameters

In order to qualify the use of an optical fiber or an optical fiber system for proper transmission, several key measurements are performed.

- End-to-end optical link loss
- Rate of attenuation per unit length
- Attenuation contribution to splices, connectors, and couplers (events)
- Length of the fiber or distance to an event

-
- Linearity of fiber loss per unit length (attenuation discontinuities)
 - Reflectance or optical return loss (ORL)
 - Chromatic dispersion (CD)
 - Polarization mode dispersion (PMD)
 - Attenuation profile (AP)

Other measurements, such as bandwidth, may also be performed. Except for a few specific applications, these other measurements are often less important.

Some measurements require access to both ends of the fiber. Others require access to only one end. Measurement techniques that require access to only one end are particularly interesting for field applications since these measurements reduce the time spent traveling from one end of the fiber cable system to the other. Field testing of optical cables requires testing at three levels: installation, maintenance, and restoration.

2.2.3 Field Testing

The following sections provide a non-exhaustive list of the various tests that can be performed during each level of field testing. The exact nature of a testing program depends on the system design, the system criticality, and the contractual relationship between the cable and components suppliers, system owner, system installer, and system user.

2.2.3.1 Installation Tests

Pre-Installation Tests

Prior to installation, fiber inspections are performed to ensure that the fiber cables received from the manufacturer conform to the required specifications (length, attenuation, etc.) and have not been damaged during transit or cable placement.

Installation and Commissioning Tests

During installation and commissioning, tests are performed to determine the quality of cable splices and terminations (attenuation, location, and reflectance). Tests are also performed to determine that the completed cable subsystem is suitable for the intended transmission system (end-to-end loss and system optical return loss). All of these tests provide a complete set of documentation of the cable link for maintenance purposes.

2.2.3.2 Maintenance Tests

Maintenance testing involves periodic evaluation of the cable system to ensure that no degradation of the cable, splices, or connections has occurred. Tests include cable attenuation as well as attenuation and reflection of splices and terminations. In some systems, maintenance tests may be performed every few months and are compared to historical test results to provide early warning signs of degradation. In very high capacity or critical systems, automated testing devices may be employed to test the integrity of the system every few minutes to give immediate warning of degradation or outages.

2.2.3.3 Troubleshooting

During cable restoration, testing is first performed to identify the cause of the outage (transmitter, receiver, cable, or connector) and to locate the fault in the cable if the outage was caused by the cable. Testing is then performed to assess the quality of the repaired system (permanent splices). This subsequent testing is similar to the testing performed at the conclusion of cable installation.



2.3 Optical Tester Families

One of the main families of optical testers is optical handhelds. This family is comprised of handheld devices that allow for the measurement of system power level, insertion loss (IL), optical return loss (ORL), reflectometry, chromatic dispersion (CD), polarization mode dispersion (PMD), and attenuation profile (AP).



Examples of JDSU handheld optical testers

2.3.1 Light Sources

A light source is a device that provides a continuous wave (CW) and stable source of energy for attenuation measurements. It includes a source, either an LED or laser, that is stabilized using an automatic gain control mechanism. LEDs are typically used for multimode fiber. On the other hand, lasers are used for singlemode fiber applications.

The output of light from either an LED or laser source may also have the option of modulation (or chopping) at a given frequency. The power meter can then be set to detect this frequency. This method improves ambient light rejection. In this case, a 2 kHz modulated light source can be used with certain types of detectors to tone the fiber for fiber identification or for confirmation of continuity.

Comparing LEDs and lasers

Characteristics	LEDs	Lasers
Output power	Linearly proportional to the drive current	Proportional to the current above the threshold
Current	Drive current: 50 to 100 mA (peak)	Threshold current: 5 to 40 mA
Coupled power	Moderate	High
Speed	Slower	Faster
Output pattern	Higher	Lower
Bandwidth	Moderate	High
Available wavelengths	0.66 to 1.65 mm	0.78 to 1.65 mm
Spectral width	Wider (40 to 190 nm FWHM)	Narrower (0.00001 to 10 nm FWHM)
Fiber type	Multimode only	Singlemode and multimode
Ease-of-use	Easier	Harder
Lifetime	Longer	Long
Cost	Low	High

2.3.2 Power Meters

The power meter is the standard tester in a typical fiber optic technician's toolkit. It is an invaluable tool during installation and restoration.

The power meter's main function is to display the incident power on the photodiode. Transmitted and received optical power is only measured with an optical power meter. For transmitted power, the power meter is connected directly to the optical transmitter's output. For received power, the optical transmitter is connected to the fiber system. Then, the power level is read using the power meter at the point on the fiber cable where the optical receiver would be.

2.3.2.1 Detector Specifications

Currently, power meter photodiodes use Silicon (for multimode applications), Germanium (for singlemode and multimode applications), and InGas (for singlemode and multimode applications) technologies. As shown in the figure below, InGas photodiodes are more adapted to the 1625 nm wavelength than Germanium (Ge) photodiodes since Ge photodiodes are quite sensitive and drop off rapidly at the 1600 nm window.

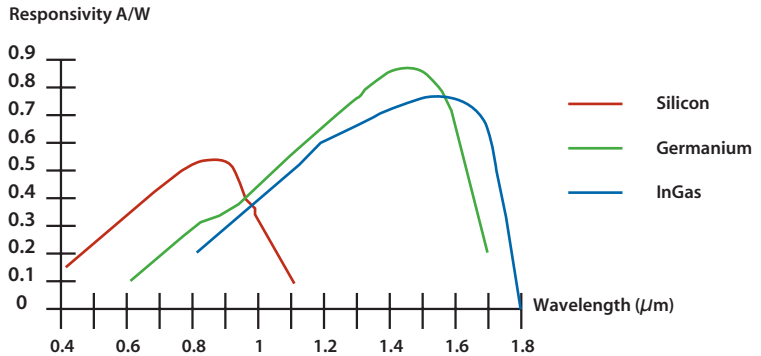

Responsivity of the three typical detector types

Features found on more sophisticated power meters may include temperature stabilization, the ability to calibrate to different wavelengths, the ability to display the power relative to “reference” input, the ability to introduce attenuation, and a high power option.

2.3.2.2 Dynamic Range

The requirements for a power meter vary depending on the application. Power meters must have enough power to measure the output of the transmitter (to verify operation). They must also be sensitive enough, though, to measure the received power at the far (receive) end of the link. Long-haul telephony systems and cable TV systems use transmitters with outputs as high as +16 dBm and amplifiers with outputs as high as +30 dBm. Receiver power levels can be as low as -36 dBm in systems that use an optical pre-amplifier. In local area networks, though, both receiver and transmitter power levels are much lower.

The difference between the maximum input and the minimum sensitivity of the power meter is termed the dynamic range. While the dynamic range for a given meter has limits, the useful power range can be extended beyond the dynamic range by placing an

attenuator in front of the power meter input. This, though, limits the low end sensitivity of the power meter.

For high power mode, an internal or external attenuator can be used. If an internal attenuator is used, it can be either fixed or switched.

Typical dynamic range requirements for power meters are as follows:

- +20 dBm to -70 dBm for telephony applications
- +26 dBm to -55 dBm for CATV applications¹
- 20 dBm to -60 dBm for LAN applications

2.3.2.3 Insertion Loss and Cut Back Measurements

The most accurate way to measure overall attenuation in a fiber is to inject a known level of light in one end and measure the level of light that exits at the other end. Light sources and power meters are the main instruments recommended by ITU-T G650.1 and IEC 61350 to measure insertion loss. This measurement requires access to both ends of the fiber.

Cut Back Method

The cut back method is the most accurate measurement, but it is also destructive and cannot be applied in the field. For this reason, it is not used during installation and maintenance. Testing using the cut back method requires first measuring the attenuation of the length of fiber under test. Then, a part of the length of the fiber is cut back from the source, and the attenuation is measured as a reference. Subtracting the two values provides the attenuation of the cut fiber.

¹ Most power meters meet these requirements through two modes of operation, a standard mode (+20 to -70 dBm) and a high power mode (+30 to -50 dBm).

Insertion Loss Method

The insertion loss method is a non-destructive method, which can be used to measure the attenuation across a fiber, a passive component, or an optical link. With this substitution method, the output from a source fiber and a reference fiber is measured directly. Then, a measurement is obtained with the fiber under test added to the system. The difference between the two results provides the attenuation of the fiber.

The purpose of the first or reference measurement is to cancel out, as much as possible, the losses caused by the various patch cables.

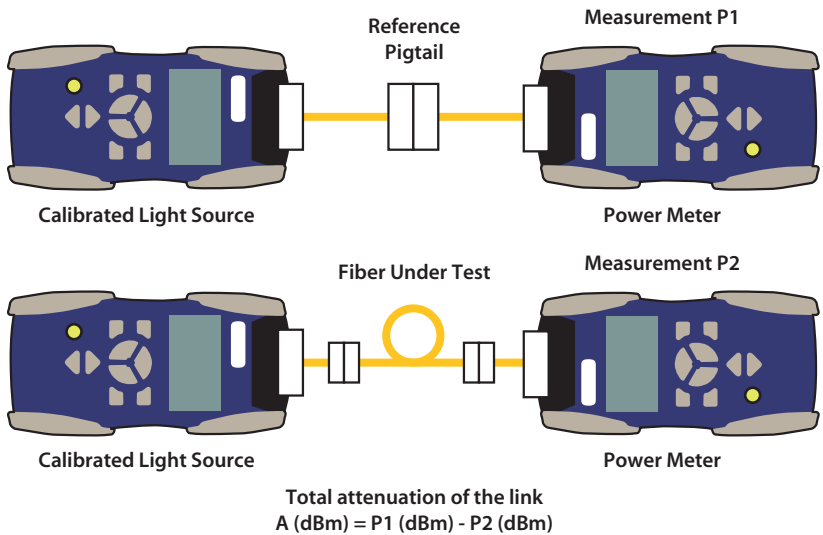

The insertion loss method uses two steps to measure the attenuation along a fiber link

It is important to note that significant variations can occur in attenuation measurements if precautions are not taken with the injection conditions.

2.3.3 Loss Test Sets

A loss test set (LTS) combines a power meter and a light source in the same instrument. It is a highly accurate tool and is used to determine the total amount of loss or attenuation in a fiber under test.

Tests are usually performed in both directions since results can differ slightly from one direction to the other. For example, attenuation through couplers and fiber core mismatches can significantly differ in either direction. To ensure a better level of accuracy, averages are calculated when qualifying a link.

With traditional light sources and power meters, the instruments must either be transferred from one end of the link to the other or a light source and a power meter are required at both ends of the link. The former requires a total of four instruments in order to perform measurements in both directions. With an LTS at each end of the link, tests can be performed in both directions using only two instruments and without the need to transfer them from one end to the other.

Bi-directional Loss Test Sets

With a bi-directional loss test set, both of the light sources and power meters are connected to the same port. Alternatively, bi-directional LTSs can be used as standalone instruments. Independent quick referencing for all built-in wavelengths can be obtained by connecting the light source and power meter of an instrument using a patch cable (loopback referencing). Although the side-by-side referencing method is more accurate, the loopback referencing method is preferred when the instruments are separate, and it is not convenient to co-locate them. When two LTSs are connected to the fiber under test, further manipulation is not required in order to carry out the bi-directional measurement.

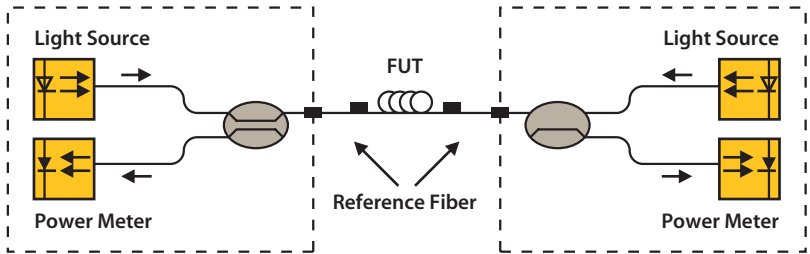

Insertion loss measurement with two bi-directional loss test sets

Most of the current LTS instruments are now fully automated bi-directional test instruments. With the press of a button, bi-directional measurement is performed in few seconds, and a complete report is generated. Automated insertion loss measurement is fast and accurate and requires less training. With automated insertion loss measurement, technicians make fewer errors, which are generally caused by bad or lost reference settings or by errors in the manual movement of the fiber while conducting the test.



OFI-2000

2.3.4 Attenuators

A fiber optic attenuator is a passive optical component that is intended to reduce the propagation of optical power in the fiber. It can provide either fixed or variable attenuation. An attenuator is the ideal tool for simulating cable loss for the testing of link power margin. A variable attenuator can be set to any loss value within the operating range using a light source and a power meter.

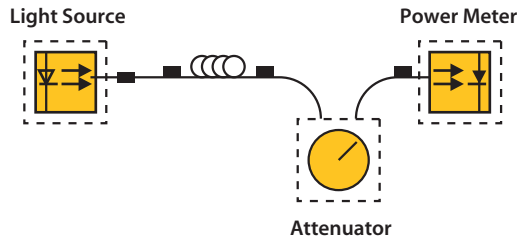

The use of an optical attenuator in optical testing

2.3.5 Optical Loss Budget

When installing a fiber network, network topology and equipment specifications must be considered. One of the major parameters requiring measurement is optical loss budget, or end-to-end optical link loss. When calculating the optical loss budget of a fiber link, the source, detector, and optical transmission line must be considered. The transmission link includes source-to-fiber coupling loss, fiber attenuation loss, and loss from all of the components along the line (connectors, splices, passive components, etc.).

The optical loss budget sits between maximum and minimum values.

- The maximum value is defined as the ratio of the minimum optical power launched by the transmitter to the minimum power level that can be received by the receiver while still maintaining communication.

- The minimum value is defined as the ratio of the maximum optical power launched by the transmitter to the maximum power level that can be received by the receiver while still maintaining communication.

An example of a typical multimode system includes the following specifications:

- Transmitter output optical power $-12 \text{ dBm} \pm 2 \text{ dBm}$
- Optical receiver sensitivity $\leq -27 \text{ dBm}$
- Optical receiver dynamic range $\geq 18 \text{ dB}$

The transmitter output optical power specification provides the maximum (-10 dBm) and minimum (-14 dBm) power levels that may occur. The optical receiver sensitivity provides the minimum power level that will be detected. The optical receiver dynamic range provides the maximum power level that can be detected ($-27 \text{ dBm} + 18 \text{ dBm} = -9 \text{ dBm}$).

In this example, the maximum optical loss budget is 13 dB based on a minimum output optical power of the transmitter of -14 dBm and a minimum optical receiver sensitivity of -27 dBm .

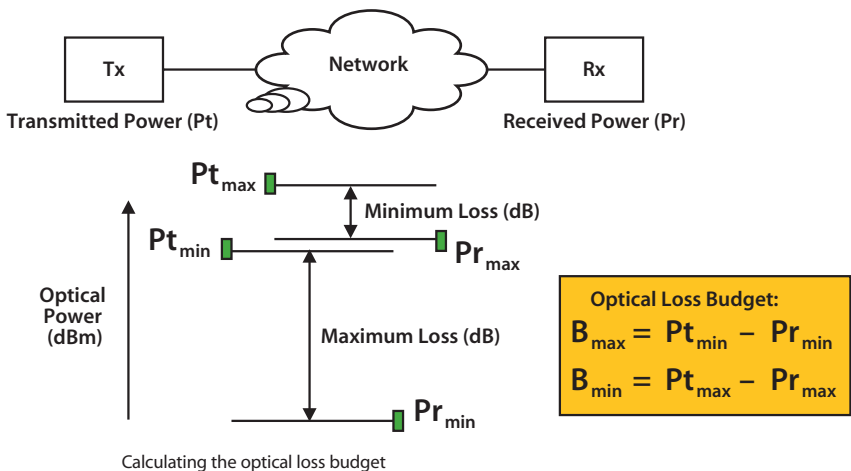

Optical loss budgets should take into account the power margins of the cable and equipment. These power margins cover allowances for the effects of time and environmental factors (launched power, receiver sensitivity, connector, or splice degradation). In order to calculate the optical loss budget, typical values of attenuations of the different fiber components are used.

0.2 dB/km for singlemode fiber loss at 1550 nm

0.35 dB/km for singlemode fiber loss at 1310 nm

1 dB/km for multimode fiber loss at 1300 nm

3 dB/km for multimode fiber loss at 850 nm

0.05 dB for a fusion splice

0.3 dB for a mechanical splice

0.5 dB for a connector pair

3.5 dB for a 1 to 2 splitter (3 dB splitting loss plus 0.5 dB excess loss)

Once the calculation of the overall optical loss budget is completed, the cable can be installed.

An example of a typical optical loss budget calculation

Network	Short Haul	Medium Haul	Long Haul
Distance (km)	30	80	200
Fiber loss (dB/km) at 1550 nm	0.25	0.22	0.19
Total fiber loss (dB/km)	7.5	17.6	38
Number of splices	15	40	50
Average splice loss	0.1	0.1	0.05
Total splice loss	1.5	4	2.5
Number of connectors	2	2	2
Average connector loss	0.5	0.5	0.5
Total connector loss	1	1	1
TOTAL LOSS	10	22.6	41.5

2.3.6 Optical Return Loss Meters

There are several methods that can be used to measure optical return loss (ORL). The most common methods use either an optical continuous wave reflectometer (OCWR) or an optical time domain reflectometer (OTDR).

2.3.6.1 OCWR Method

Using an OCWR, the light source launches a single wavelength of light at a known power level (P_0) into the fiber optic system to the fiber under test. The wavelength must be similar to the wavelength that the communication system will use in its intended application. A directional coupler then routes the backreflections to the detector in the optical power meter.

There are two steps that must be performed when measuring the ORL with an OCWR.

1. A reference optical power measurement (background return loss) is performed using a non-reflective (< -70 dB) termination plug. The non-reflective termination plug can be replaced by a mandrel wrap or by index-matching gel.

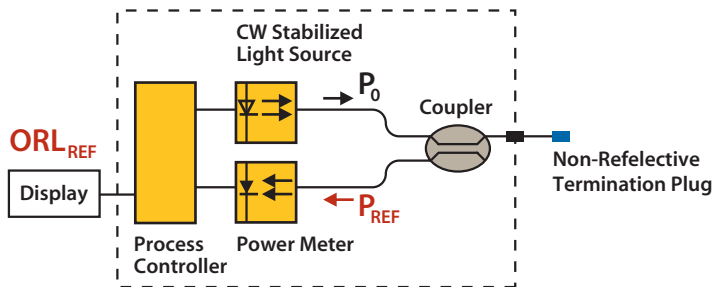

ORL referencing using the OCWR method

- Once referencing is complete, the jumper (coupler/splitter) is connected to the device under test (DUT). Care must be taken at the DUT termination in order to avoid glass-to-air back reflection (-14 dB), which will affect the ORL value. The ORL can then be calculated after measuring the level of reflected optical power in the device under test.

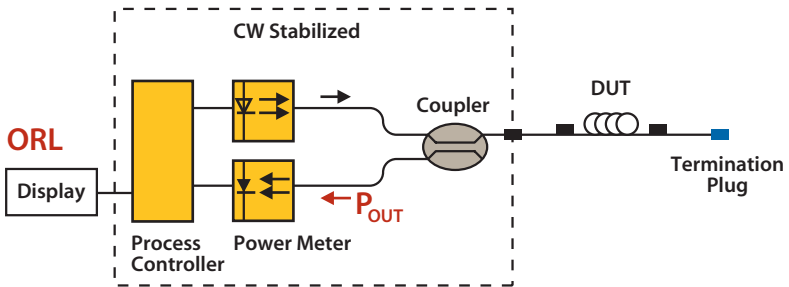

ORL measurement using the OCWR method

2.3.6.2 OTDR Method

The OTDR launches light pulses into the fiber under test and collects backscatter information as well as Fresnel reflections. The light received by the OTDR corresponds to the reflected power according to the injected pulsewidth.

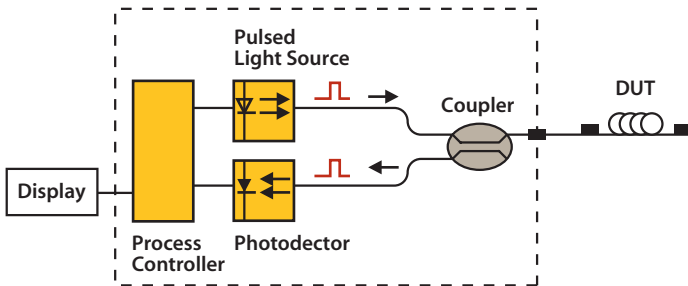

Setup using the OTDR method

The ORL is calculated after measuring the level of reflected optical power in the fiber under test according to the pulsewidth.

$$\text{ORL} = 10 \text{ Log} \left(\frac{P_o \Delta t}{\int P_r(z) \cdot dz} \right)$$

Where P_o is the output power of the OTDR, Δt is the OTDR pulsewidth, and $\int P_r(z) \cdot dz$ is the total backreflection over the distance of the fiber.

2.3.6.3 Differences between the OCWR Method and the OTDR Method

ORL measurement with an OTDR is easier to perform than with an OCWR since no power output referencing is required. For technicians used to dealing with OTDR measurements, the ORL value becomes a de facto standard. JDSU's optical test platforms offer additional value with an automatic ORL measurement while measuring an OTDR trace. Using an OTDR also provides the ability to measure the ORL for a given fiber span or for a specific point on the fiber, such as connector reflectance.

However, the OCWR method remains more accurate (approximately ± 0.5 dB) than the OTDR method (approximately ± 2 dB) and allows for the measurement of very short fiber lengths, such as one or two meter patchcords.

Comparing OCWR and OTDR

Characteristics	OCWR	OTDR
Spatial resolution	No	Yes
Accuracy (typical)	± 0.5 dB	± 2 dB
Dynamic range	Up to 70 dB	---
Typical applications	<ul style="list-style-type: none"> Total link ORL and isolated event reflectance measurements during fiber installation and commissioning 	<ul style="list-style-type: none"> Spatial characterization of reflective events and estimation of the total ORL during installation Perfect tool for troubleshooting when discrete elements contributing to the ORL must be identified Locates reflective events Single-ended measurement
Strengths	<ul style="list-style-type: none"> Accurate Fast Provides real-time results Simple and easy (direct result) 	
Weaknesses	<ul style="list-style-type: none"> Manipulations (reference measurements required) 	<ul style="list-style-type: none"> Accuracy Long acquisition times

2.3.7 Mini-OTDR and Fault Locators

Using the same basic technology as the OTDR, a new class of instruments became available in the early 1990's. Known as mini-OTDRs, these fiber test instruments are typically battery-powered, lightweight, and small enough to be carried in one hand.

The simplest and earliest designs of these instruments were capable of fault location at a minimum, and some were capable of providing rudimentary analysis (attenuation, rate of attenuation, distance, and reflectance) of fiber systems. Modern designs mimic the capabilities of mainframe OTDRs, including sophisticated analysis (automatic event detection, table of events, optical return loss, trace overlay, and bi-directional analysis) of fiber links, data storage capabilities, additional functionality (light source, power meter, talk set, and visual fault locator), and even the modularity formerly found only in mainframe OTDRs.

The mini-OTDR has become the popular choice for pre-installation and restoration testing where ease-of-use and mobility are important.



JDSU mini-OTDR test instrument

2.3.8 Fiber Characterization Testing

Most fiber characterization test platforms are modular in design and contain a mainframe and different plug-in modules, which can be added to suit the required application. These platforms can usually perform complete fiber characterization including the following tests:

- Loss testing
- Optical return loss (ORL)
- Optical time domain reflectometry (OTDR)
- Polarization mode dispersion (PMD)
- Chromatic dispersion (CD)
- Attenuation profile (AP) or spectral attenuation (SA)



JDSU fiber characterization test platform

Fiber characterization platforms contain a controller, display, operator controls, and optional equipment, such as a talk set, printer, input/output interfaces, modem, and hard/floppy disk

drives with CD-ROM read/write capabilities. Test modules can be plugged into or stacked onto the controller in order to offer the required test capabilities. Test modules can have single or multiple measurement capabilities, depending on the measurement method. For example, CD/OTDR or AP/PMD testing capabilities may be offered in one test module, allowing for complete fiber characterization using one small and lightweight unit.

The OTDR is the main piece of test equipment that is used to analyze a fiber optic link. It consists of a laser source and an optical detector. It can be set to allow for testing using various wavelength and fiber type combinations.

Polarization mode dispersion testing is required for high-speed transmission systems (≥ 10 Gb/s) or for very long-haul networks. PMD measurements can be performed using different standardized methods, such as fixed analyzer, interferometry, or Jones-Matrix Eigenanalysis. Each method requires access to both ends and uses a light source at the far end.

Chromatic dispersion is another major limiting factor in high-speed transmission systems. CD measurements can be performed using different standardized methods, such as phase shift, differential phase shift, or pulse delay. With the exception of the pulse delay method, a variable wavelength or broadband light source is required to perform CD measurement. The pulse delay method is a single-ended test method in which a four-wavelength OTDR functions as the CD analyzer.

Attenuation profile, or spectral attenuation profile, testing is an optical fiber characterization test that verifies gain-flattened network components. The AP solution consists of an optical spectrum analyzer, a broadband source (or a broadband power meter), and a tunable light source.

2.3.9 Other Test Tools

2.3.9.1 Talk Sets

Talk sets transmit voice over installed fiber cable, allowing for communication between technicians who are splicing or testing the fiber, even when they are in the field. There are talk sets for both singlemode and multimode applications. Talk sets can be used to replace mobile or land-based telecommunications methods, which may not be cost-effective or may not operate in the field environment.

2.3.9.2 Visual Fault Locators

Visual fault locators (VFLs) are red light lasers that can visually locate faults, up to approximately five kilometers away. By sending visual light, technicians can easily see breaks and bends in the fiber as the light exits the fiber. This function makes them especially useful for continuity testing of patchcords, jumpers, or short sections of fiber.



A visual fault locator

VFLs can also be used in conjunction with splicing machines for the identification of fibers to be jointed and with an OTDR for the analysis of failures that occur within the dead zone.

The most popular VFLs are composed of a HeNe source. VFLs can use 635 nm, 650 nm, or 670 nm lasers or LEDs, according to the required application.

- 670 nm VFLs perform better at longer distances
- 635 nm VFLs provide higher visual accuracy

2.3.9.3 Fiber Identifiers

Fiber identifiers (FIs) are test instruments that can identify an optical fiber by detecting the optical signals being transmitted through the singlemode fiber. By utilizing local detection technology (non-destructive macro-bend detection), the FI eliminates the need to open the fiber at the splice point for identification. FIs can detect continuous wave, live optical transmission, and most 270 Hz, 1 kHz, and 2 kHz modulated tones. Some FI models use LEDs to simply indicate the presence of traffic on the fiber as well as the direction of the transmission and the modulated tones. Other FI models are capable of measuring the fiber's relative power and displaying it.



A fiber identifier

2.3.9.4 Clip-on Devices

Clip-on devices are used in conjunction with a suitable light source to enable power measurement without disconnecting or damaging the fiber. Clip-on devices perform measurements by inserting a controlled bend in the fiber and measuring the level of light that exits the fiber. This measurement can be performed either non-intrusively (low bend) or intrusively (strong bend).

2.3.9.5 Fiber Inspection Microscopes

Fiber inspection microscopes, with white LEDs for coaxial illumination, produce excellent detail of scratches and contamination. A well-made connector will have a smooth, polished, and scratch-free finish. Fiber inspection microscopes are strongly recommended for troubleshooting optical connectors and for the critical examination of polish quality.



A handheld fiber inspection microscope

2.3.9.6 Video Inspection Scopes

Video inspection scopes are portable video microscopes that are used to inspect fiber optic terminations. Made with an LED light source and a video camera (CCD), video inspection scopes are used to inspect installed connectors that are located inside hardware devices or on the backside of patch panels. The use of a video inspection scope eliminates the need to access the backside of patch panels or to disassemble hardware devices prior to inspection. They can also be used to check fiber end surfaces and pigtailed.



A video inspection scope with a handheld display

2.3.10 Monitoring Systems

Test equipment can be integrated into an automated monitoring system and connected to a network operation center (NOC). The system monitors the network continuously, alerting technicians and managers to faults as they occur. As a result, network downtime, maintenance resource requirements, and costs are dramatically reduced, enabling network operators to improve the quality of their services and maintain cost-effective service level agreements.

The monitoring system is comprised of remote test units (RTU), which are installed at strategic points throughout the optical network, and a central management system. An RTU includes an optical switch, which is used to connect to individual fibers, and an OTDR module.

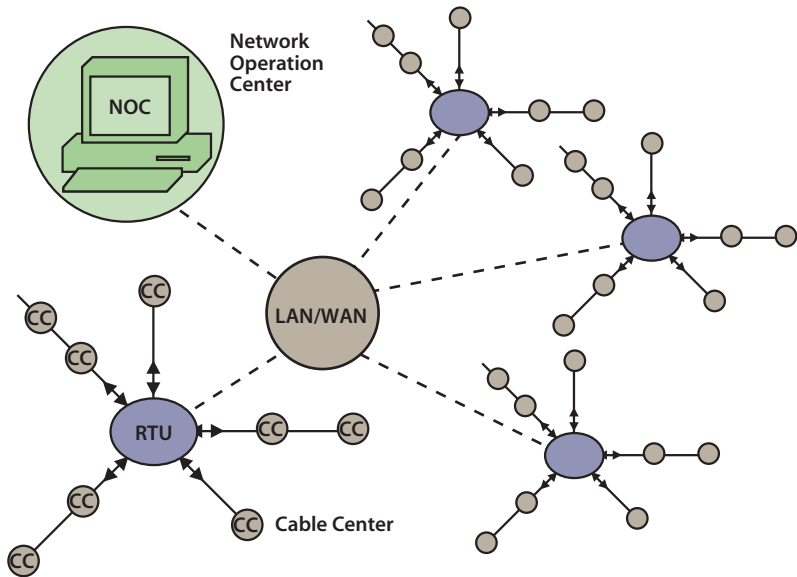

A remote monitoring system

Most network operators initially use a fiber monitoring system to look for and sectionalize a catastrophic failure of the link. In this case, the RTU is connected to only one or two fibers out of service (dark fiber) in a multi-fiber link. This set up assumes that in the event of a catastrophic break, all of the fiber strands will be cut.

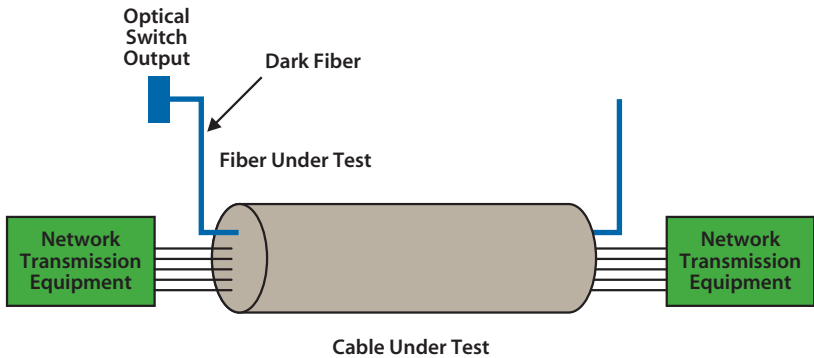

Out-of-service monitoring of a link

Remote monitoring can also be accomplished simultaneously with live traffic, using wavelength division multiplexing (WDM) transmission along with test equipment that operates at wavelengths differing from those of the transmission system.

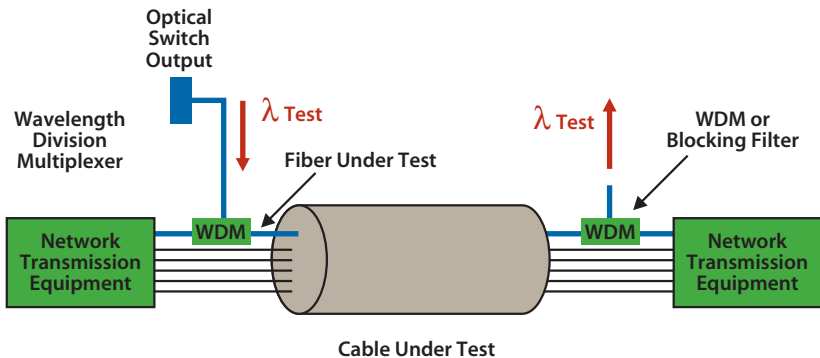

In-service monitoring of a link



Optical Time Domain Reflectometry

Chapter 3



3.1 Introduction to OTDR

An Optical Time Domain Reflectometer (OTDR) is a fiber optic tester for the characterization of fiber and optical networks. The purpose of an OTDR is to detect, locate, and measure events at any location on the fiber link.

One of the main benefits of an OTDR is that it operates as a one-dimensional radar system, allowing for complete fiber characterization from only one end of the fiber. The resolution of an OTDR is between 4 centimeters and 40 meters.

Using an OTDR, geographic information with regard to localized loss and reflective events is generated, providing technicians with a pictorial and permanent record of the fiber's characteristics. This record may be used as the fiber's performance baseline.



3.2 Fiber Phenomena

The OTDR's ability to characterize a fiber is based on detecting small signals that are returned back to the OTDR in response to the injection of a large signal. This process is similar to radar technology. In this regard, the OTDR depends on two types of optical phenomena: Rayleigh scattering and Fresnel reflections. The major difference between these two phenomena is as follows:

- Rayleigh scattering is intrinsic to the fiber material itself and is present along the entire length of the fiber. Since Rayleigh scattering is uniform along the length of the fiber, discontinuities in Rayleigh scattering can be used to identify anomalies in the transmission along the fiber link.
- Fresnel reflections, on the other hand, are *point* events and occur only where the fiber comes in contact with air or another media, such as a mechanical connection, splice, or joint.

3.2.1 Rayleigh Scattering and Backscattering

When a pulse of light is injected into fiber, some of the photons of light are scattered in random directions due to microscopic particles. This effect, referred to as Rayleigh scattering, provides amplitude and temporal information along the length of the fiber.

In addition, some of the light is scattered back in the opposite direction of the pulse. This is referred to as the backscattered signal.

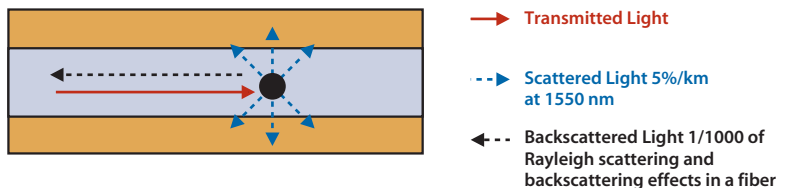

Rayleigh scattering and backscattering effects in a fiber

Scattering loss is the main loss mechanism for fiber operating in the three telecom windows (850 nm, 1310 nm, and 1550 nm). Typically, a singlemode fiber transmitting light at 1550 nm, with a fiber

scattering coefficient (α_s) of 0.20 dB/km, will lose 5% of the transmitted power over a 1 km section of fiber.

The fiber backscattering factor (S) describes the ratio between the backscattered power and the scattered power. S is typically proportional to the square of the numerical aperture (NA).

Depending on the fiber scattering coefficient (α_s) and the fiber backscattering factor (S), the fiber backscatter coefficient (K) is the ratio of the backscattered power to the energy launched into the fiber. The logarithmic value of the fiber backscatter coefficient, normalized to a 1 ns pulse duration, is given by:

$$K_{ns} \text{ (dB)} = 10\text{Log } K_{(s^{-1})} - 90 \text{ dB}$$

When K_{ns} is -80 dB, then for a 1 ns pulse duration, the backscatter power is -80 dB below the incident pulse peak power.

It is important to note that -80 dB at 1 ns is equivalent to -50 dB at 1 μ s.

$$K_s \text{ (dB)} = K_{ns} \text{ (dB)} + 30 \text{ dB}$$

The Rayleigh scattering effect is similar to shining a flashlight in the fog at night. The light beam gets diffused, or scattered, by the particles of moisture. A thick fog will scatter more of the light because there are more water particles to obstruct it.

The backscattering effect depends on the launched power P_o (W), the pulsewidth Δt (s), the backscattering coefficient K (s^{-1}), the distance d (m), and the fiber attenuation a (dB/km).

$$\text{Backscattering} = P_o \cdot \Delta t \cdot K10^{-\alpha d/5}$$

A higher density of dopants in a fiber will also create more scattering and thus higher levels of attenuation per kilometer. An OTDR can measure the levels of backscattering very accurately and can measure small variations in the characteristics of fiber at any point along its length.

While Rayleigh scattering is quite uniform down the length of any given fiber, the magnitude of Rayleigh scattering varies significantly at different wavelengths (as shown in the following diagram) and with different fiber manufacturers.

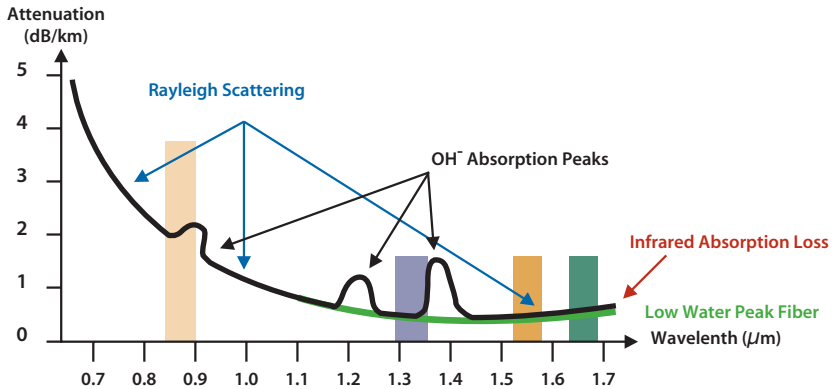

Fiber attenuation as a function of wavelength

3.2.2 Fresnel Reflection and Backreflection

Fresnel reflection occurs when light reflects off a boundary of two optical transmissive materials, each having a different refractive index. This boundary can occur at a joint (connector or mechanical splice), at a non-terminated fiber end, or at a break.

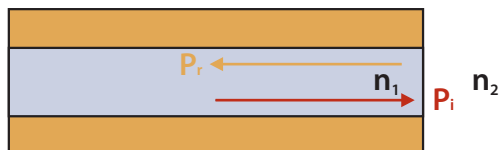

Light reflection phenomenon

3.2.2.1 Power Reflection Factor

$$R = \frac{P_r}{P_i} = \frac{(n_1 - n_2)^2}{(n_1 + n_2)^2} ; \text{ from fiber to air } R = 4\%$$

The magnitude of the Fresnel reflection is dependent on the relative difference between the two refractive indexes. The power level of reflected light depends on the boundary surface smoothness.

3.2.2.2 Backreflection

Backreflection, or reflectance, is the amount of light that is reflected back from an optical component of a transmission link (a connector, joint, or mechanical splice). It is the logarithmic ratio of the reflected power (P_r) to the incident power (P_i) at a particular point.

$$\text{Reflectance} = 10 \text{Log} \frac{P_r}{P_i} ; \text{ expressed in dB } (\leq 0)$$

Where P_r is the reflected power (W), P_i is the incident power (W), and n_1 and n_2 are the refractive indexes.

Reflected light from a boundary between a fiber and air has a theoretical value of -14 dB. This value can be over 4000 times more powerful than the level of the backscattered light. This means that the OTDR detector must be able to process signals that can vary in power enormously. Connectors using an index-matching gel can reduce Fresnel reflection since the gel minimizes the glass-to-air index ratio.

The table below provides the typical reflectance values for a fiber optic connection or break.

Transition Boundries	Fresnel Reflection
Glass-to-air	-14 dB
PC-to-PC connector	-35 dB to -50 dB
APC-to-APC connector	-55 dB to -65 dB

3.3 OTDR Technology

The OTDR injects light energy into the fiber through a laser diode and pulse generator. The returning light energy is separated from the injected signal using a coupler and is fed to the photodiode. The optical signal is converted to an electrical value, amplified, sampled, and displayed on a screen.

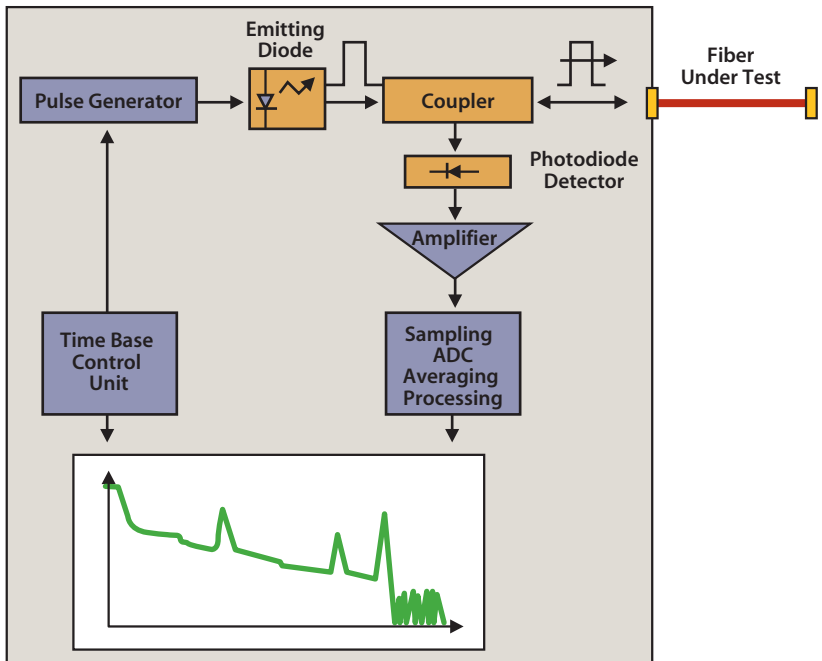

A schematic diagram showing OTDR technology

3.3.1 Emitting Diodes

Laser diodes are semiconductors in which the light is generated by an electrical current. Emitting diodes are selected according to the central (or peak) wavelength, the wavelength spectral width, and the output power.

Central Wavelength

The central wavelength is the wavelength at which the source emits the most power. It should reflect the test wavelength specifications, for example, 850 nm, 1300 nm, 1310 nm, 1550 nm, and 1625 nm. The central wavelength is usually specified with its uncertainty, which varies from ± 30 nm to ± 3 nm (for specific temperature-controlled lasers).

Spectral Width

Light is emitted in a range of wavelengths centered around the central wavelength. This range is called the spectral width of the source.

Output Power

For best results, as much of the source's power is coupled into the fiber. The key requirement is that the output power of the source must be strong enough to provide sufficient power to the detector at the receiving end.

There are two main types of emitting diodes used in OTDR technology: light emitting diodes and laser diodes.

3.3.1.1 Light Emitting Diodes

A light emitting diode (LED) is a semiconductor device that emits a narrow spectrum of light. This effect is a form of electroluminescence. In general, LEDs are less powerful than lasers, but they are much less expensive. LEDs are mainly used in multimode OTDR applications (850 and 1300 nm).

3.3.1.2 Laser Diodes

A laser (light amplification by stimulated emission of radiation) is an optical source that emits photons in a coherent beam. Laser light consists of a single wavelength emitted in a narrow beam.

Fabry Perot Laser

The Fabry Perot (FP) laser is the most common type of laser diode used in OTDR design. It is cost effective and has the ability to deliver a high output power level. It is mainly used in singlemode OTDR applications at 1310 nm, 1550 nm, and 1625 nm wavelengths. FP lasers emit light at a number of discrete wavelengths, delivering a spectral width between 5 nm and 8 nm.

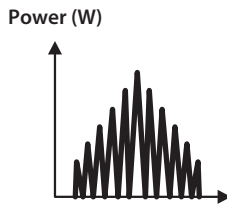

The emitted spectrum of a Fabry Perot laser

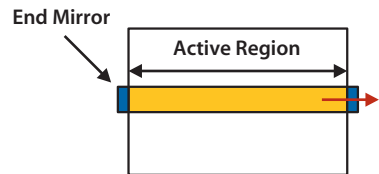

A schematic diagram of a Fabry Perot laser

Distributed Feedback Laser

A distributed feedback (DFB) laser is far more precise than a simple Fabry Perot laser, but its output power delivery capability is much lower. FP lasers emit a lot of harmonics over a wavelength range of 5 nm and 8 nm. DFB lasers, on the other hand, select only one principal wavelength in the FP laser spectrum, providing a narrow spectral width of <0.1 nm.

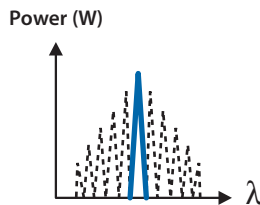

The emitted spectrum of a DFB laser

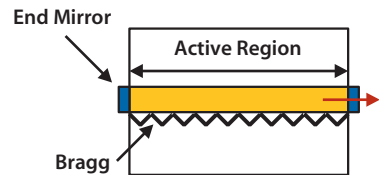

A schematic diagram of a DFB laser

Basically, a DFB laser functions like an FP laser except that it contains a Bragg grating inside its cavity between the two end mirrors.

Comparing LEDs and lasers

Characteristics	LEDs	Lasers
Output power	Linearly proportional to the drive current	Proportional to the current above the threshold
Current	Drive current: 50 to 100 mA (peak)	Threshold current: 5 to 40 mA
Coupled power	Moderate	High
Speed	Slower	Faster
Output pattern	Higher	Lower
Bandwidth	Moderate	High
Available wavelengths	0.66 to 1.65 mm	0.78 to 1.65 mm
Spectral width	Wider (40 to 190 nm FWHM)	Narrower (0.00001 to 10 nm FWHM)
Fiber type	Multimode only	Singlemode and multimode
Ease-of-use	Easier	Harder
Lifetime	Longer	Long
Cost	Low	High

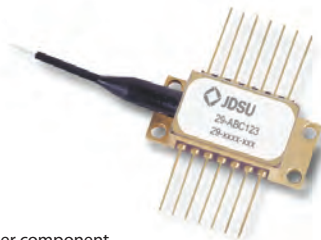

An example of a laser component

3.3.2 Using a Pulse Generator with a Laser Diode

A pulse generator controls a laser diode, which sends powerful light pulses (from 10 mW to 1 W) into the fiber. These pulses can have a width in the order of 2 ns to 20 μ s and a pulse recurrence frequency of several kHz. The duration of the pulse (pulsewidth) can be set by the technician for different measurement conditions. The repetition rate of the pulses is limited to the rate at which the pulse return is completed, before another pulse is launched. The light goes through the coupler/splitter and into the fiber under test.

The OTDR measures the time difference between the outgoing pulse and the incoming backscattered pulses, hence the term *time domain*. The power level of the backscattered signal and the

reflected signal is sampled over time. Each measured sample is called an *acquisition point*, and these points can be plotted on an amplitude scale with respect to time relative to the timing of the launch pulse. The OTDR then converts this time domain information into distance, based on the user-entered refractive index of the fiber. The refractive index entered by the user is inversely proportional to the velocity of propagation of light in the fiber. The OTDR uses this data to convert time to distance on the OTDR display and divides this value by two to factor in the round trip (or two way) travel of light in the fiber. If the user-entered refractive index is incorrect or inaccurate, the resulting distances displayed by the OTDR may be incorrect.

Velocity of propagation, or group delay, of light in a fiber:

$$V = \frac{c}{n} \approx \frac{3 \cdot 10^8}{1.5} = 2 \cdot 10^8 \text{ m/s}$$

Where V is the group delay, c is the speed of light in a vacuum (2.99792458 m/s), and n is the refractive index.

OTDR time to distance conversion (round trip):

$$L = V \cdot \frac{t}{2} = \frac{c \cdot t}{2 \cdot n} = 10^8 \cdot t$$

Where L is the distance (m), V is the group delay, t is the pulsewidth (s), c is the speed of light in a vacuum (2.99792458 m/s), and n is the refractive index.

Example: For a 10 ns pulsewidth, $L = 10^8 \times 10 \text{ ns} = 1 \text{ m}$

3.3.3 Photodiodes

OTDR photodiodes are specifically designed to measure the extremely low levels of backscattered light at 0.0001% of that sent by the laser diode. Photodiodes must be able to detect the relatively high power of reflected pulses of light. This can cause problems when analyzing the results of an OTDR.

The bandwidth, sensitivity, linearity, and dynamic range of the photodiode along with its amplification circuitry are carefully selected and are designed to be compatible with the required pulsewidths and with the power levels backscattered from the fiber.



An example of a photodiode component

3.3.4 Time Base and Control Unit

The control unit is the brain of the OTDR. It reads all of the acquisition points, performs the averaging calculations, plots them as a logarithmic function of time, and then displays the resulting trace on the OTDR screen.

The time base controls the pulsewidth, the spacing between subsequent pulses, and the signal sampling. Multiple passes are used to improve the signal-to-noise ratio of the resulting trace. Since noise is random, many data points at a given distance are acquired and averaged. This allows the noise level to average out and approach zero. The resulting data more accurately represents the backscatter or reflection level at a given point. An OTDR may acquire up to 128,000 data points and may fire thousands of pulses. Therefore, it is imperative that the OTDR processor is very powerful, providing the technician with fast performance measurement and analysis.

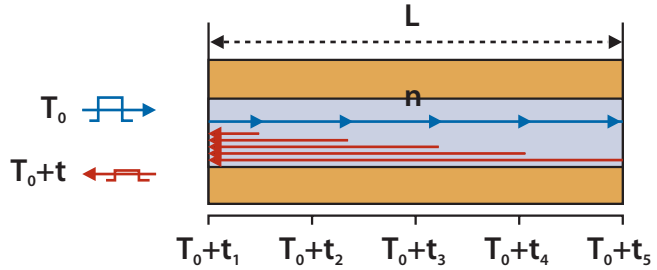

The OTDR pulse generation principle

The OTDR display shows a vertical scale of attenuation in dB and a horizontal scale of distance in km (or feet). Numerous acquisition points are plotted, representing the backscatter signature of the fiber under test.

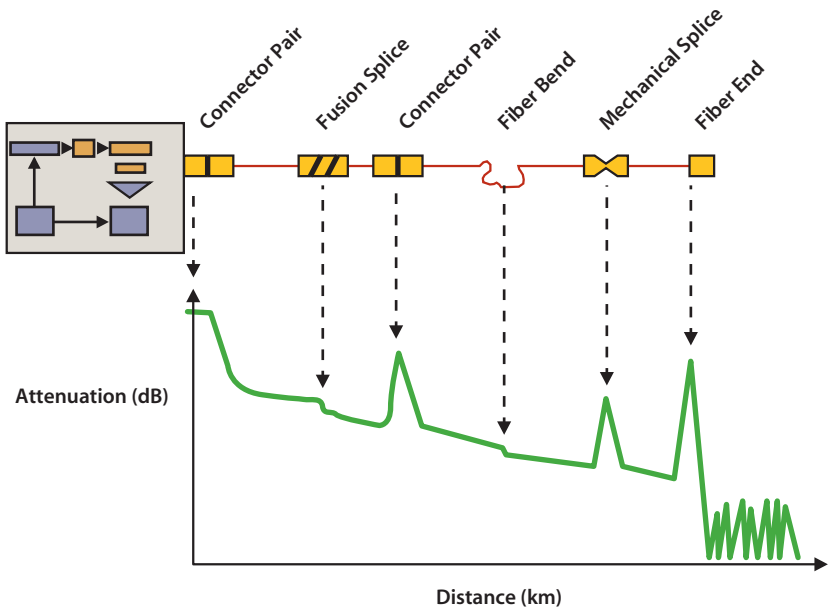

A typical OTDR trace

3.4 OTDR Specifications

3.4.1 Dynamic Range

The dynamic range is one of the most important characteristics of an OTDR since it determines the maximum observable length of a fiber. Therefore, it also determines the OTDR suitability for analyzing any particular network. The higher the dynamic range, the higher the signal-to-noise ratio and the better the trace and the event detection. The dynamic range is relatively difficult to determine since there is no standard computation method used by all the manufacturers.

3.4.1.1 Definitions of Dynamic Range

Dynamic range can be defined as the difference between the extrapolated point of the backscatter trace at the near end of the fiber (taken at the intersection between the extrapolated trace and the power axis) and the upper level of the noise floor at (or after) the fiber end. Dynamic range is expressed in decibels (dB). The measurement is performed over a three minute period, and the results are averaged.

Depending on the noise level reference, there are many definitions of dynamic range. These definitions introduce values that are not immediately comparable.

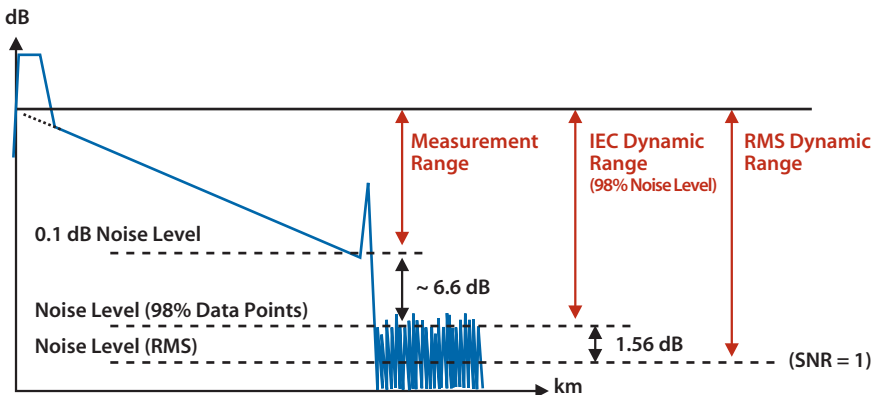

Different definitions of dynamic range

IEC (98% data points of the noise level)

One method of determining dynamic range is to specify the upper level of the noise as the upper limit of the range, which contains at least 98% of all noise data points. This definition is endorsed by the International Electrotechnical Commission (IEC) in the IEC 61746 standard. This value of dynamic range is also recommended by Telcordia.

RMS

The RMS (root mean square) dynamic range, also termed SNR=1, is the difference between the extrapolated point of the backscatter trace at the near end of the fiber (taken at the intersection between the extrapolated trace and the power axis) and the RMS noise level. If the noise is Gaussian, the RMS value can be compared to the IEC 61746 definition by subtracting 1.56 dB from the RMS dynamic range.

N=0.1 dB

This dynamic range definition provides the technician with an idea of the limit that the OTDR can measure when the noise level is 0.1 dB on the trace. The difference between the N=0.1 and the SNR=1 (RMS) definition is approximately 6.6 dB less. This means that an OTDR, which has a dynamic range of 28 dB (SNR=1), can measure a fiber event of 0.1 dB with a dynamic range of 21.4 dB.

End Detection

The end detection dynamic range is the one way difference between the top of a 4% Fresnel reflection at the start of the fiber and the RMS noise level. This value is approximately 12 dB higher than the IEC value.

Telcordia Measurement Range

The Telcordia measurement range of an OTDR is defined as the maximum attenuation (one way) that can be placed between its optical output port and the event being measured for which it can accurately identify the event. Four OTDR measurement ranges are identified:

1. Splice loss measurement range
2. Fiber attenuation coefficient measurement range

3. Non-reflective fiber end measurement range
4. Reflective fiber end measurement range

4% Fresnel Reflection

This dynamic range measurement is more an echometric parameter than a reflectometric parameter. It represents the ability of the instrument to perceive the peak of a Fresnel reflection for which the base cannot be perceived. It is defined as the maximum guaranteed range over which the far end of the fiber is detected. It can have a minimum value of 0.3 dB higher than the highest peak in the noise level.

Whichever noise definition is used, the dynamic range only defines an attenuation loss between two levels on the OTDR trace (from maximum signal level to noise floor level). The closer the signal is to the noise floor, though, the noisier it becomes.

The value of the dynamic range, for each definition, can also be stated according to different measurement conditions.

Typical value

This represents the average or mean value of the dynamic range of the OTDRs being manufactured. An increase of approximately 2 dB is typically shown in comparison with the specified value.

Specified value

This is the minimum dynamic range specified by the manufacturer for its OTDR.

Over a temperature range or at room temperature

At low and high temperatures, the dynamic range typically decreases by 1 dB.

3.4.2 Dead Zone

3.4.2.1 Why is there a Dead Zone?

An OTDR is designed to detect the backscattered level all along the fiber link. It measures backscattered signals, which are much smaller than the signal that was injected into the fiber. The photodiode, the component receiving the signal, is designed to receive a given level range. When there is a strong reflection, the power received by the photodiode can be more than 4,000 times higher than the backscattered power, saturating the photodiode. The photodiode requires time to recover from its saturated condition. During this time, it will not detect the backscattered signal accurately. The length of fiber that is not fully characterized during this period (pulsewidth + recovery time) is termed the dead zone.

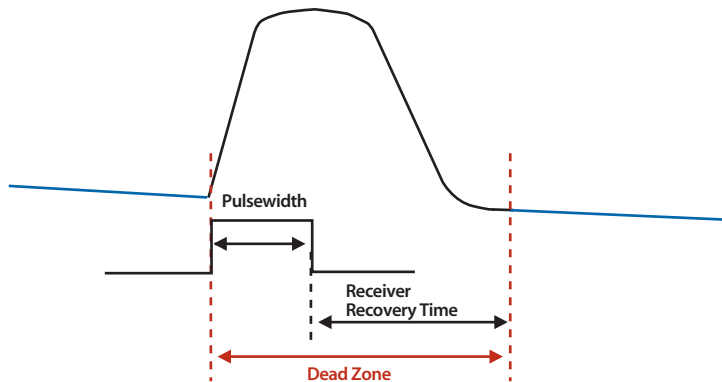

The OTDR dead zone

3.4.2.2 Attenuation Dead Zone (ADZ)

The attenuation dead zone, defined in the IEC 61746 standard for a reflective or attenuating event, is the region after the event where the displayed trace deviates from the undisturbed backscatter trace by more than a given vertical value DF (usually 0.5 dB or 0.1 dB). Telcordia specifies a reflectance of -30 dB and a loss of 0.1 dB and

provides several different locations. In general, the higher the reflected power that is sent back to the OTDR, the longer the attenuation dead zone.

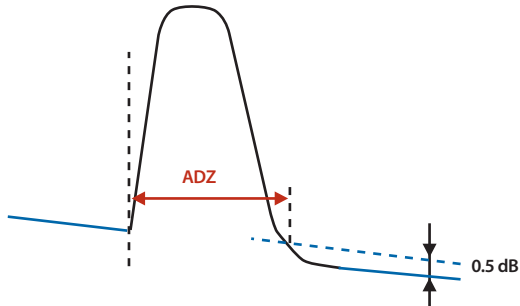

Measurement of the attenuation dead zone (ADZ)

The attenuation dead zone depends on the pulsewidth, the reflectance value of the first reflective event, the loss of this event, and the distance location. It usually indicates the minimum distance after a reflective event where a non-reflective event, a splice for example, can be measured.

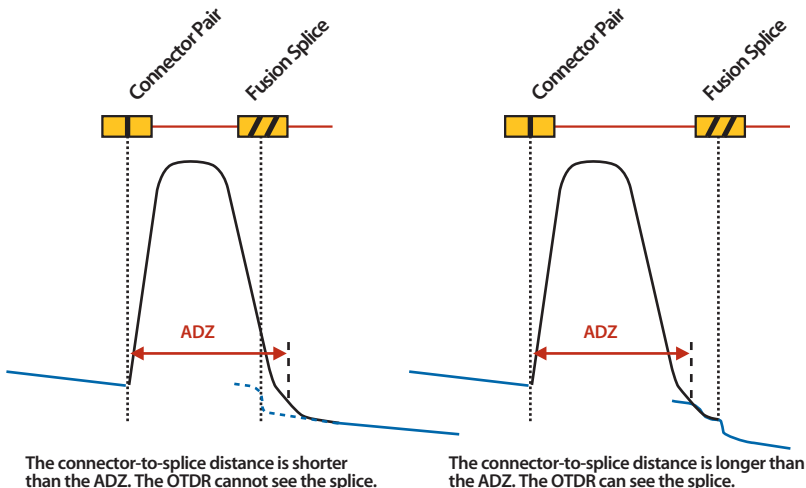

The connector-to-splice distance is shorter than the ADZ. The OTDR cannot see the splice.

The connector-to-splice distance is longer than the ADZ. The OTDR can see the splice.

Attenuation dead zone (ADZ) and minimum distance measurements

At short pulsewidths, the recovery time of the photodiode is the primary determinant of the attenuation dead zone and can be five to six times longer than the pulsewidth itself. At long pulsewidths, the pulsewidth itself is the dominant factor. In this case, the attenuation dead zone is, in effect, equal to the pulsewidth. The attenuation dead zone specified for the OTDR is generally measured at the shortest pulsewidth.

Telcordia specifies two types of attenuation dead zones: front end dead zone and network dead zone. Historically, the connection between the OTDR was highly reflective. This often caused the dead zone at the front end of the OTDR to be much longer than the dead zone that resulted from a reflection in the network. Currently, the OTDR connection has been engineered to have very low reflectance, and there is little difference between the front end dead zone and the network dead zone.

If the front end attenuation dead zone of the OTDR in use is large, the effect can be minimized using a launch cable.

3.4.2.3 Event Dead Zones

Reflective Events

For a reflective event, the event dead zone is defined as the distance between the two opposite points that are 1.5 dB (or FWHM) down from the unsaturated peak of a single reflective event.

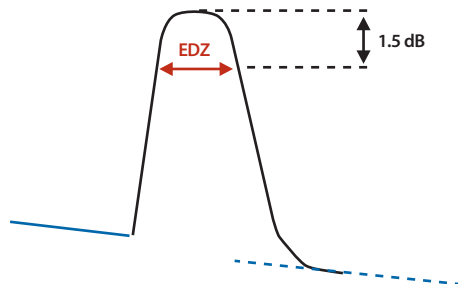

The event dead zone (EDZ) of a reflective event

Non-Reflective Events

For a non-reflective event, the event dead zone can be described as the distance between the points where the beginning and ending levels of a splice or a given value (≤ 1 dB) are within ± 0.1 dB of their initial and final values.

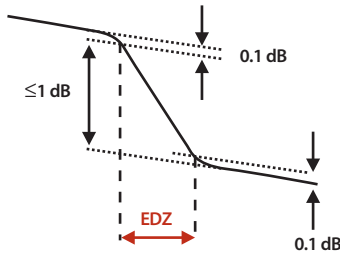

The event dead zone (EDZ) of a non-reflective event

The event dead zone depends on the pulsewidth and can be reduced using smaller pulsewidths. The effects of the front end event dead zone can also be reduced using a launch cable.

The event dead zone is the minimum distance where two consecutive reflective events can still be distinguished. The distance to each event can be measured, but the separate losses of each event cannot be measured.

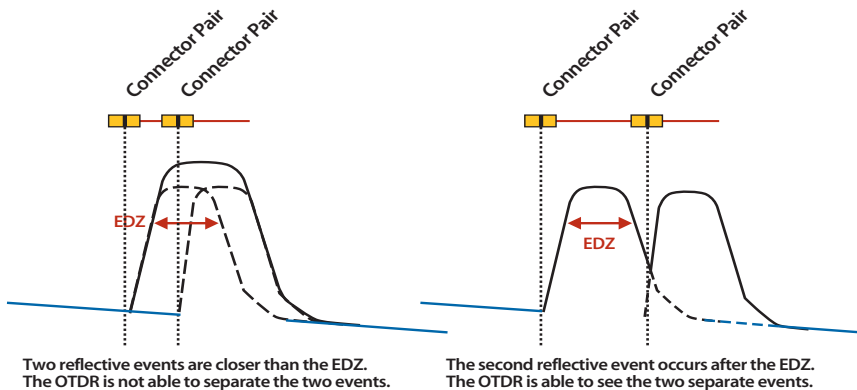

Event dead zone and connector discrimination by the OTDR

3.4.3 Resolution

There are four main types of resolution parameters: display (cursor), loss (level), sampling (data point), and distance.

3.4.3.1 Display Resolution

There are two types of display resolution: readout and cursor. Readout display resolution is the minimum resolution of the displayed value. For example, an attenuation of 0.031 dB will have a resolution of 0.001 dB. The cursor display resolution is the minimum distance, or attenuation, between two displayed points. A typical cursor display resolution value is 1 cm or 0.001 dB.

3.4.3.2 Loss Resolution

Loss resolution is governed by the resolution of the acquisition circuit. For two similar power levels, it specifies the minimum loss difference that can be measured. This value is generally around 0.01 dB.

3.4.3.3 Sampling Resolution

Sampling (or data point) resolution is the minimum distance between two acquisition points. This data point resolution can be within centimeters, depending on pulse-width and range. In general, the more data points, the better the sampling resolution. Therefore, the number of data points an OTDR can acquire is an important performance parameter. A typical high-resolution OTDR may have a sampling resolution of 1 cm.

3.4.3.4 Distance Resolution

Distance resolution is very similar to sampling resolution. The ability of the OTDR to locate an event is affected by the sampling resolution. If the OTDR only samples acquisition points every 4 cm, it can only locate a fiber end within ± 4 cm. Similar to the sampling resolution, the distance resolution is a function of the pulsewidth and the range. This specification must not be confused with distance accuracy, which is discussed below.

3.4.4 Accuracy

The accuracy of a measurement is its capacity to be compared with a reference value.

3.4.4.1 Linearity (Attenuation Accuracy)

The linearity of the acquisition circuit determines how close an optical level corresponds to an electrical level across the entire range. Most OTDRs have an attenuation accuracy of ± 0.05 dB/dB. Some OTDRs can have a higher attenuation accuracy of ± 0.03 dB/dB. If an OTDR is non-linear, then for long fiber, the section loss values will change significantly.

3.4.4.2 Distance Accuracy

The distance accuracy depends on the following parameters:

Group Index

Whereas refractive index refers to a single ray in a fiber, group index refers to the propagation velocity of all of the light pulses in the fiber. The accuracy of the OTDR distance measurements depends on the accuracy of the group index.

Time Base Error

This is due to the inaccuracy of the quartz in the timing mechanism, which can vary from 10^{-4} to 10^{-5} seconds. In order to calculate the distance error, the time base error must be multiplied by the measured distance.

Distance Error at the Origin

A typical distance accuracy value for the JDSU T-BERD/MTS-8000 OTDR is calculated by:

$\pm 1 \times 10^{-5} \times \text{distance} \pm 1 \text{ m} \pm \text{sampling resolution} \pm \text{group index uncertainties}$

3.4.5 Wavelength

OTDRs measure according to wavelength. The current wavelengths for OTDR are 850 nm and 1300 nm for multimode fiber and 1310 nm, 1550 nm, and 1625 nm for singlemode fiber. A 1625 nm laser diode can be used in remote monitoring systems, which carry live traffic. The purpose of using the 1625 nm wavelength is to avoid interference with traffic at 1310 nm and around 1550 nm.

Other wavelengths, although not frequently used, are also available:

- The 1244 nm and 1383 nm wavelengths can be used for attenuation measurement around the fiber absorption peaks. Due to its high loss, though, the 1244 nm is no longer used, and 1383 nm is the preferred wavelength.
- The 1420 nm, 1450 nm, and 1480 nm wavelengths can be used for Raman-amplified systems.
- The 1490 nm wavelength can be used for FTTH systems.

Some OTDRs display the exact laser wavelengths that are used for measurement. Generally, though, only the generic wavelength is provided.





Using an Optical Time Domain Reflectometer (OTDR)

Chapter 4

4.1 Introduction

The OTDR is very versatile and has many applications. It is important to select an OTDR that has the appropriate specifications for the application. With recent breakthroughs in modularity, some OTDRs, such as the JDSU T-BERD®/MTS family, can be configured flexibly in order to perform testing on almost any kind of fiber optic network, singlemode or multimode, short or long haul.

The use of an OTDR can be broadly defined as a two-step process:

1. Acquisition: The OTDR acquires the data and displays the results either numerically or graphically.
2. Measurement: The technician analyzes the data and, based on the results, makes a decision to either store, print, or go to the next fiber acquisition.

4.2 Acquisition

Most modern OTDRs automatically select the optimal acquisition parameters for a particular fiber by sending out test pulses in a process known as auto-configuration. Using the auto-configuration feature, the technician selects the wavelength (or wavelengths) to test, the acquisition (or averaging) time, and the fiber parameters (refractive index, for example, if not already entered).

There are three major approaches to configuring an OTDR:

1. A technician may simply allow the OTDR to auto-configure and accept the acquisition parameters selected by the OTDR.
2. A more experienced technician may allow the OTDR to auto-configure, but then the technician will analyze the results briefly and change one or more acquisition parameters in order to optimize the configuration for the particular test requirements.
3. The experienced technician may choose not to use the auto-configuration feature altogether and will enter the acquisition parameters based on his experience and knowledge of the link under test.

Typically, when testing multi-fiber cables, once the appropriate acquisition parameters are selected, they are locked in. The same parameters are then used for every fiber in the cable. This dramatically speeds up the acquisition process and provides for consistency in the data, which is helpful when analyzing or comparing fibers.

In the following sections, various acquisition parameters and their effects on the resulting OTDR trace are discussed.

4.2.1 Injection Level

The injection level is defined as the power level in which the OTDR injects light into the fiber under test. The higher the injection level, the higher the dynamic range. If the injection level is low, the OTDR trace will contain noise, and measurement accuracy will be diminished. Poor launch conditions, resulting in low injection levels, are the primary reason for reductions in accuracy.

The presence of dirt on connector faces and damaged or low quality pigtails or patchcords are the primary causes of low injection levels. It is important that all physical connection points are free of dust and dirt in an optical system. With core diameters of less than 10 μm in singlemode systems, the presence of even a 4 μm speck of dirt or dust (approximately the size of the particulate matter in cigarette smoke) can severely degrade injections levels.

Cleaning kits are available for optical systems from basic tools, such as isopropyl cleaning solution, Joseph paper, compressed air spays, and ready-to-use impregnated wipes, to more advanced methods using cassette cleaners and integrated cleaning systems, such as the Westover Scientific CleanBlast™. Mating dirty connectors to the OTDR connector may scratch the OTDR connector, permanently degrading launch conditions.

Some OTDRs, like the T-BERD/MTS family, display the measured injection level during real-time acquisition or just prior to averaging. The result is displayed on a bar graph using a relative scale, rating the injection level from good to bad.

To determine the relative quality of the injection level, the OTDR looks out a short distance, observes the backscatter returned from the launch pulse, and compares this value to an expected value. It is sometimes possible for the injection level to display as unacceptable when it is in fact acceptable. This can occur if there is an attenuator or splitter on the system near the OTDR. In this case, the backscatter level will be lower than expected as measured by the injection level meter. Although the injection level increases as pulsewidth increases, the scale displayed is calibrated separately for each pulsewidth. Therefore, the scale is meaningful at any pulsewidth, and increasing the pulsewidth will not change a bad injection level to a good one.

4.2.2 OTDR Wavelength

The behavior of an optical system is directly related to its wavelength of transmission. Optical fiber exhibits different loss

characteristics at different wavelengths. In addition, splice loss values also differ at different wavelengths.

In general, the fiber should be tested using the same wavelength that is used for transmission. Therefore, 850 nm and/or 1300 nm wavelengths are used for multimode systems, and 1310 nm and/or 1550 nm wavelengths are used for singlemode systems.

If testing is only performed at one wavelength, the following parameters must be considered:

1. For a given dynamic range, using a wavelength of 1550 nm will see longer distances down the same fiber than a wavelength of 1310 nm due to the lower attenuation in the fiber.
 - 0.35 dB/km at 1310 nm means that approximately 1 dB of signal is lost every 3 km.
 - 0.2 dB/km at 1550 nm means that approximately 1 dB of signal is lost every 5 km.
2. Singlemode fiber has a larger mode field diameter at 1550 nm than at 1310 nm and at 1625 nm than at 1550 nm. Larger mode fields are less sensitive to lateral offset during splicing, but they are more sensitive to losses incurred by bending during installation or in the cabling process.
 - 1550 nm is more sensitive to bends in the fiber than 1310 nm. This is termed *macro bending*.
 - 1310 nm will generally measure splice and connector losses higher than 1550 nm. These results are from a Corning study of over 250 splices where the 1310 nm values were shown to be typically higher by 0.02 dB over the 1550 nm values for dispersion shifted fiber.

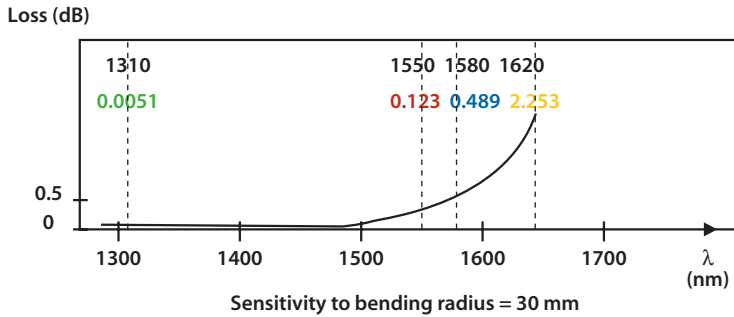
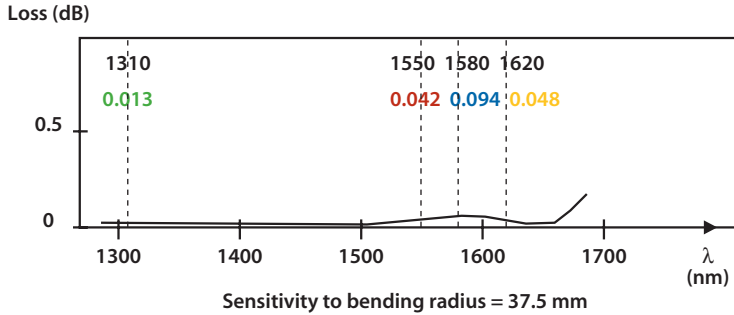

The effects of bending on a fiber

4.2.2.1 From 1310/1550 nm to 1625 nm Testing

OTDRs are the ideal tools for detecting and locating bends in a fiber link, as shown in the graph below. The green trace represents measurement at 1310 nm, the violet trace at 1550 nm, and the red trace at 1625 nm.



The OTDR graph shows a bend located at 3040 m at 1550 nm and 1625 nm

The bending effect is not a new phenomenon. In the past, when the 1550 nm wavelength was first introduced and added to the 1310 nm transmission wavelength, the bending effect was analyzed. For example, many optical fiber reports were generated comparing 1550 nm splice losses to 1310 nm splice losses in order to detect possible bending effects.

Now that OTDR technology has moved into the 1625 nm wavelength area of the spectrum, the same analysis of bending effects must occur.

4.2.2.2 When Should Links be Tested at 1625 nm?

Networks do not always need to be tested at the 1625 nm wavelength. There are three key circumstances in which 1625 nm testing is required.

1. Upgrading of current networks: This is especially important for DWDM network upgrades that will use or plan to use the L and U bands.
2. Installation of new fiber networks: Using today's testing tools, the additional time required to perform testing at 1625 nm

compared to current 1310/1550 nm has become negligible. This has pushed installers to perform testing at all three wavelengths, essentially future-proofing their networks.

3. In-service testing: This is a well-known application used for remote fiber test systems (RFTS) and for all types of networks. However, for maintenance purposes, classical non-L band transmission, or typical PON networks, if couplers are available in the network with open ends, then contra-propagation testing can be performed at the 1625 nm wavelength without perturbing the 1310/1490/1550 nm transmission. An example of contra-propagation testing is OTDR measurements made at the opposite end of the transmission laser. For high power level transmission systems, it is mandatory to compensate the test wavelength for the effects of Raman scattering.

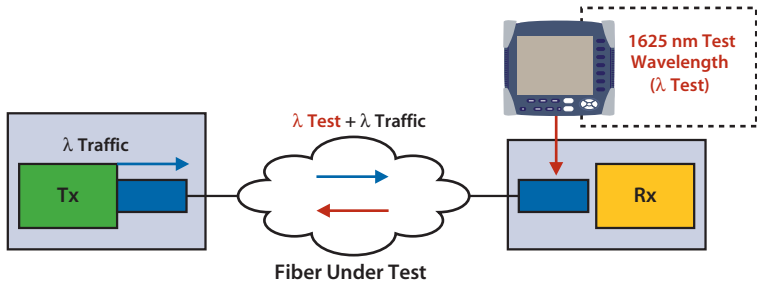

In-service testing at 1625 nm using the contra-propagation method

4.2.3 Pulsewidth

The duration of the OTDR pulsewidth controls the amount of light that is injected into a fiber. The longer the pulsewidth, the greater the amount of light energy injected. The more light energy injected, the greater the amount of light, which is backscattered or reflected back from the fiber to the OTDR.

Long pulsewidths are used to see long distances down a fiber cable. Long pulsewidths also produce longer areas in the OTDR trace waveform where measurements are not possible. This is termed the

dead zone of the OTDR. Short pulsewidths, on the other hand, inject lower levels of light, but they also reduce the dead zone of the OTDR.

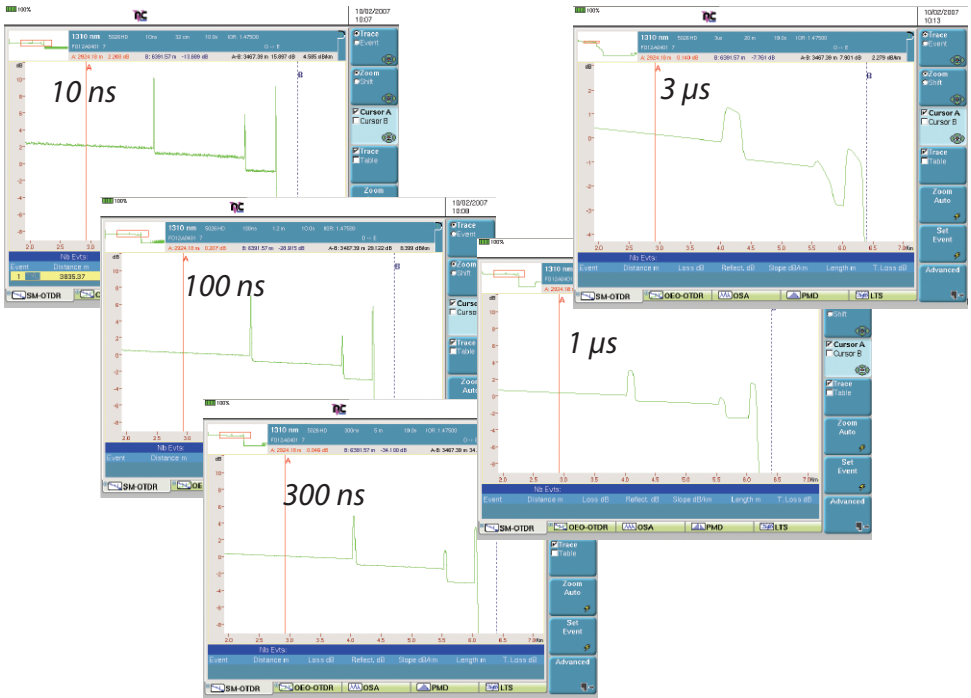

Fiber measurement using different pulsewidths

The duration of the pulsewidth is usually given in nanoseconds, but it can also be estimated in meters according to the following formula:

$$D = \frac{cT}{2n}$$

Where c is the speed of light in a vacuum (2.99792458×10^8 m/s), T is the pulse duration in ns, and n is the refractive index.

For example, a 100 ns pulse can be interpreted as a 10 m pulse.

Time or Pulsewidth	5 ns	10 ns	100 ns	1 μ s	10 μ s	20 μ s
Distance or Fiber Length	0.5m	1 m	10 m	100 m	1 km	2 km

Comparing pulsewidth to the fiber length

4.2.4 Range

The range of an OTDR is the maximum distance that the OTDR can acquire data samples. The longer the range, the further the OTDR will shoot pulses down the fiber. The range is generally set at twice the distance to the end of the fiber. If the range is set incorrectly, the trace waveform may contain measurement artifacts, such as ghosts.

4.2.5 Averaging

The OTDR detector functions at extremely low optical power levels (as low as 100 photons per meter of fiber). Averaging is the process by which each acquisition point is sampled repeatedly, and the results are averaged in order to improve the signal-to-noise ratio.

By selecting the time of acquisition or the number of averages, technicians can control the process of averaging within the OTDR. The longer the time or the higher the number of averages, the more signal the trace waveform will display in random noise conditions.

The relationship between the acquisition time (number of averages) and the amount of improvement to the signal-to-noise ratio is expressed by the following equation:

$$\Delta\text{SNR}=5\text{Log}_{10}\sqrt{N}$$

Where N is the ratio of the two averages.

Note: The noise distribution is considered random for this formula.

For example, an acquisition using three minute averaging will improve the dynamic range by 1.2 dB when compared to an acquisition using one minute averaging.

Averaging improves the signal-to-noise ratio by increasing the number of acquisitions, but the time it takes to average the trace is also increased. However, according to the equation, beyond a certain acquisition time, there is no advantage to be gained since only the signal remains. In theory, multiplying the averaging acquisition time by four will provide a +1.5 dB increase in the dynamic range.

4.2.6 Fiber Parameters

Several other parameters, which are related to the fiber, can affect OTDR results.

4.2.6.1 Refractive Index

The refractive index (n) is directly related to distance measurements. When comparing distance results from two acquisitions, technicians must ensure that the appropriate refractive index is used. If the refractive index reported by the fiber manufacturer is used, the OTDR will report the fiber length accurately.

However, particularly during fault location, technicians want to determine the cable length using an OTDR. Fiber length and cable length are not identical, though, and differ due to the over length of the fiber in the buffer tube and the geometry (helixing) of the buffer tubes in the cable. The ratio between the fiber length and cable length, termed the helix factor, varies depending on the cable fiber count, the cable design, and even the cable manufacturer.

While the helix factor may be reported by the manufacturer, the lack of precision of the value causes a large amount of uncertainty in fault location. For this reason, it is often recommended to measure a known length of similarly constructed cable and determine the effective refractive index that will allow the OTDR to report cable length instead of fiber length.

4.2.6.2 Backscatter Coefficient

The backscatter coefficient (K) tells the OTDR the relative backscatter level of a given fiber. The backscatter coefficient is set at the factory, and generally, the technician will not change this parameter. Changing the backscatter coefficient will affect the reported value of reflectance and the optical return loss.

While the assumption is made that the backscatter coefficient for the entire span is consistent, it is possible that there are very slight variations from one fiber span to another. This variation can cause measurement anomalies, such as splices with negative loss values (or gainers).

Typical backscatter coefficients at 1 ns for singlemode and multimode fiber are as follows:

- Standard singlemode fiber
 - 79 dB at 1310 nm
 - 81 dB at 1550 nm
 - 82 dB at 1625 nm
- Standard multimode fiber
 - 70 dB at 850 nm
 - 75 dB at 1300 nm

4.3 Measurement

Most modern OTDRs perform fully automatic measurements with very little input from the technician.

4.3.1 Event Interpretation

In general, there are two types of events: reflective and non-reflective.

4.3.1.1 Reflective Events

Reflective events occur where there is a discontinuity in the fiber, causing an abrupt change in the refractive index. Reflective events can occur at breaks, connector junctions, mechanical splices, or the indeterminate end of fiber. For reflective events, connector loss is typically around 0.5 dB. For mechanical splices, though, the loss typically ranges from 0.1 dB up to 0.2 dB.

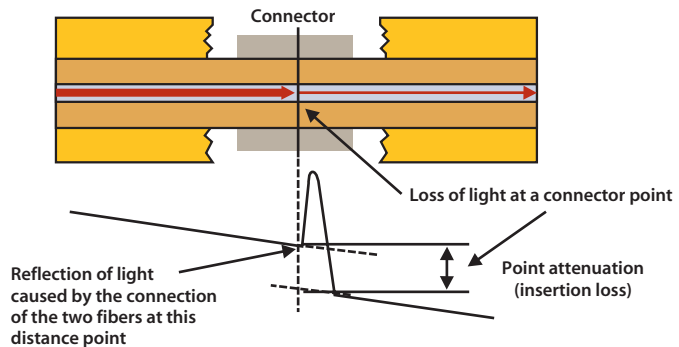

A reflective event at a connector junction

If two reflective events are very close together, the OTDR may have problems measuring the loss of each event. In this case, the loss of the combined events is displayed. This typically occurs when measuring a short fiber length, such as a fiber jumper.

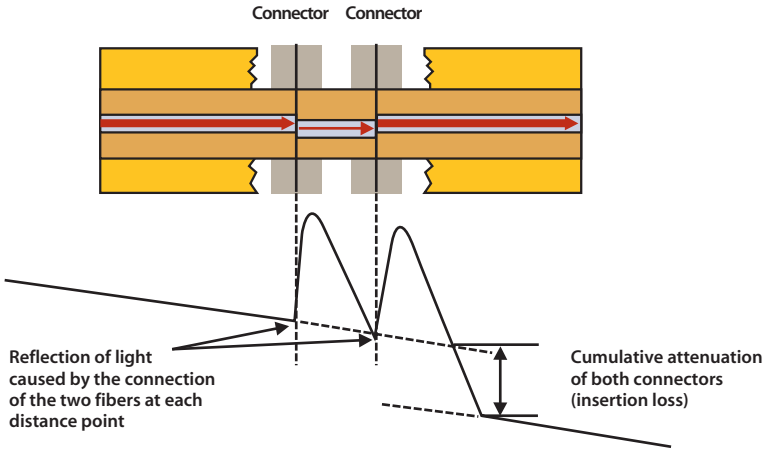

A reflective event at two connector junctions, which are located close together

In the case of a fiber end, the reflective event will fall into the noise and the measurement of attenuation is not performed.

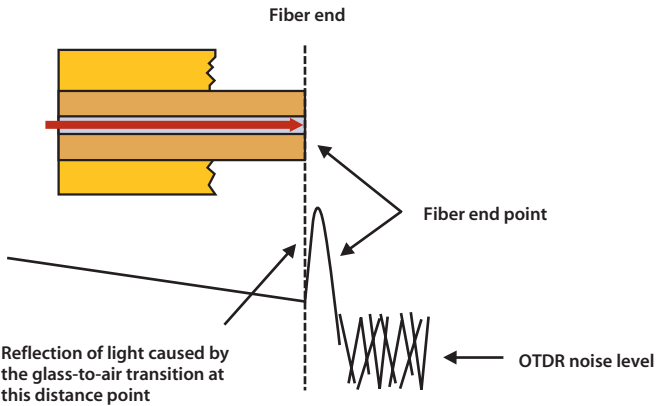

A reflective event at a fiber end

Fiber ends can also cause a non-reflective event. In this case, no reflectance is detected.

4.3.1.2 Non-reflective Events

Non-reflective events occur where there are no discontinuities in the fiber and are generally produced by fusion splices or bending losses, such as macro bends. Typical loss values range from 0.02 dB up to 0.1 dB, depending on the splicing equipment and operator.

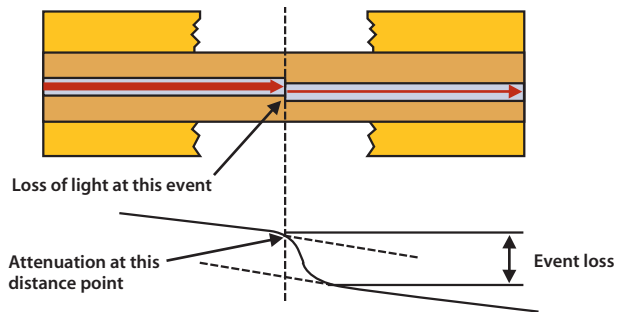

A non-reflective event

For non-reflective events, the event loss can appear as an event gain, displaying a step-up on the OTDR trace.

4.3.2 OTDR Measurements

The following measurements can be performed by an OTDR:

- For each event: Distance location, loss, and reflectance
- For each section of fiber: Section length, section loss (in dB), section loss rate (in dB/km), and optical return loss (ORL) of the section
- For the complete terminated system: Link length, total link loss (in dB), and ORL of the link

4.3.3 Measurement Methods

The OTDR allows technicians to perform measurements on the fiber span in three different ways: full-automatic, semi-automatic, and manual measurement functions. Technicians can also use a combination of these methods.

4.3.3.1 Full-Automatic Function

Using the full-automatic function, the OTDR detects and measures all of the events, sections, and fiber ends automatically, using an internal detection algorithm.

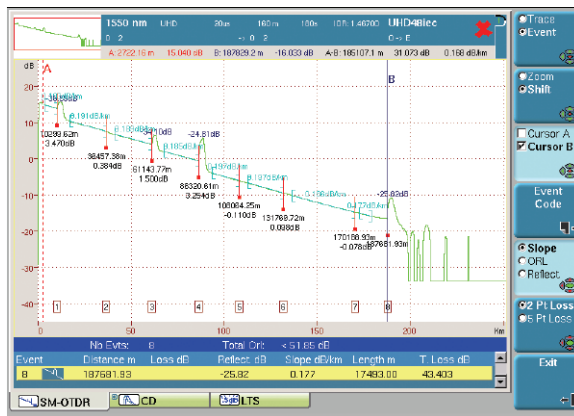

Automatic event detection using the JDSU T-BERD/MTS platforms

4.3.3.2 Semi-Automatic Function

When the semi-automatic function is selected, the OTDR measures and reports an event at each location (distance) where a marker has been placed. These markers can be placed either automatically or manually.

The semi-automatic function is of high interest during span acceptance (after splicing), when the technician completely characterizes all events along the span in order to establish baseline

data. Since automatic detection will not detect and report a non-reflective event with a zero loss, a marker is placed at that location so that the semi-automatic analysis will report the zero loss.

Further analysis of the trace using a PC software application, such as the JDSU OFS-100 FiberTrace, allows for bidirectional analysis of the span. The use of the semi-automatic function at fixed marker locations ensures consistency in the number of events from fiber to fiber and from measurements in the opposite direction.

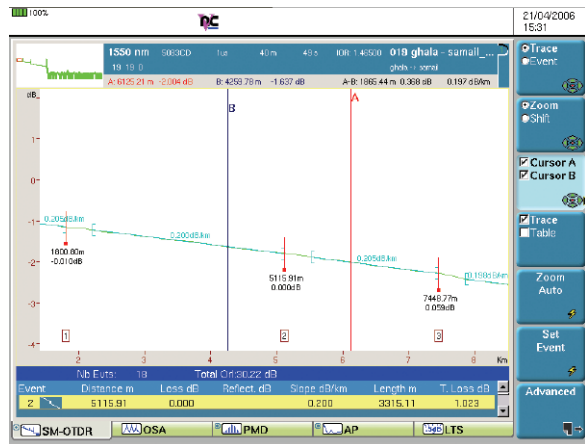

Semi-automatic measurement of a 0 dB splice loss

4.3.3.3 Manual Measurement Function

For even more detailed analysis or for special conditions, technicians completely control the measurement function manually. In this case, the technician places two or more cursors on the fiber in order to control the way the OTDR measures the event. Depending on the parameter being measured, the technician may need to position up to five cursors in order to perform a manual measurement. While this is the slowest and most cumbersome method of measurement, it is important to have this capability

available for those fiber spans whose design or construction are very unusual and are difficult to analyze accurately using automated algorithms.

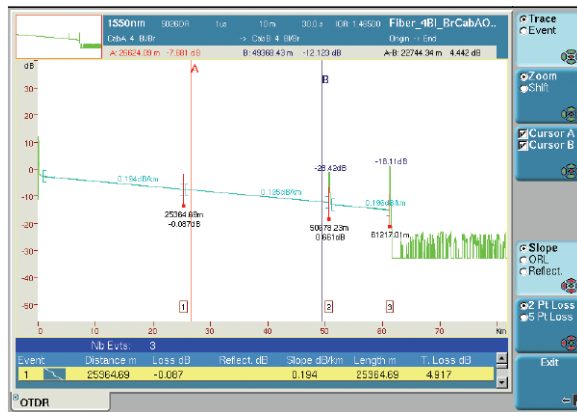

Manual measurement using cursors A and B

4.3.4 Slope

The slope, or fiber linear attenuation, can be measured (in dB/km) either using the 2-point method or by using the least squares approximation (LSA) method. The LSA method attempts to determine the measurement line that has the closest fit to the set of acquisition points. The LSA method is the most precise way to measure fiber linear attenuation, but it requires a continuous section of fiber, a minimum number of OTDR acquisition points, and a relatively clean backscatter signal, which is free of noise.

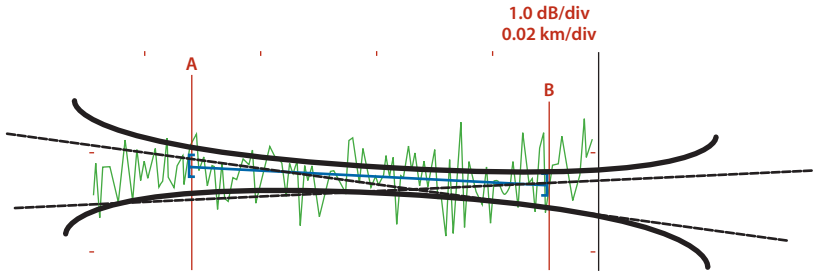

The least squares approximation method

The standard deviation of the slope (dB/km) depends on:

- The local noise level (and distribution)
- The number of acquisition points used by the LSA method

Section loss can be reported in dB or dB/km. Typical section losses range from 0.17 to 0.22 dB/km for 1550 nm systems, 0.30 to 0.35 dB/km for 1310 nm singlemode systems, 0.5 to 1.5 dB/km for 1300 nm multimode systems, and 2 to 3.5 dB/km for 850 nm systems.

4.3.5 Event Loss

Using manual measurement, there are two ways to measure event loss: the 2-point method and the 5-point method.

4.3.5.1 2-Point Method

For the 2-point method, the technician positions the first cursor on the linear backscatter level before the event and the second cursor on the linear backscatter level after the event. The event loss is then the difference between these two cursor measurements.

This method can be used for both reflective and non-reflective events. However, the precision of the 2-point method depends on the technician's ability to place the cursors at the correct positions and can be compromised if the trace has a large amount of residual noise. If the trace is very noisy or spiky, then the technician should try to place the cursor on a data point on the trace that is not

located at the top of a spike or the bottom of a trough. This is, in effect, a form of visual averaging of the trace.

If the technician is using the 2-point method to measure a point event, such as a splice, as opposed to a length of fiber, then the technician should be aware that the result will also include the effects of any fiber losses between the cursors because the distance between the cursors is non-zero.

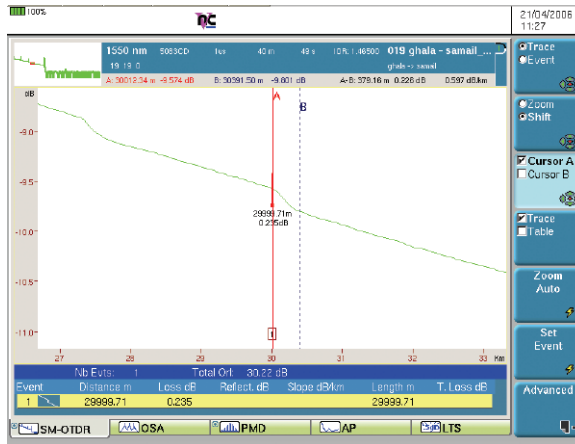

Using the 2-point measurement method between cursors A and B

4.3.5.2 5-Point Method

The purpose of the 5-point measurement method of point events is to reduce the effects of noise on the fiber span before and after the event. This is accomplished by performing a least squares approximation analysis on the fiber span. This process minimizes the additional fiber loss that is reported as event loss due to the non-zero distance between the cursors.

For the 5-point method, the software uses the position of the five cursors to extrapolate the fiber data before and after the event and performs a zero distance measurement of the loss at the event

location. This method can be used to measure the loss of both non-reflective and reflective events.

The technician first obtains a slope measurement before and after the event on the linear backscattered level of the trace. The fifth point of measurement is placed just before the event where the backscatter trace suddenly deviates. The loss measurement is then taken at this event location. The 5-point method is more precise than the 2-point method since the OTDR compares the difference between two linear backscatter levels.

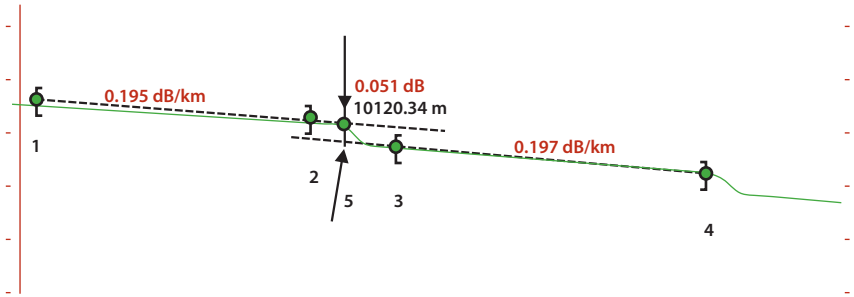

Using the 5-point measurement method

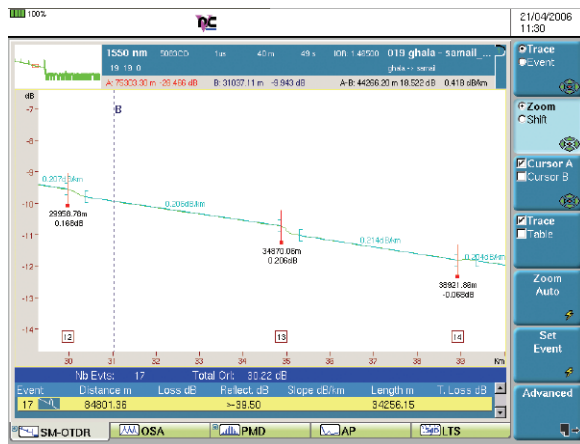

4.3.6 Reflectance

The reflectance of an event represents the ratio of the reflected power to the incident power at a discrete location on the fiber span. Reflectance is expressed in decibels (dB). A small negative value indicates a higher reflection than a large negative value. That is, a reflectance of -33 dB is larger than a reflectance of -60 dB. A larger reflectance will appear as a higher peak on the trace waveform.

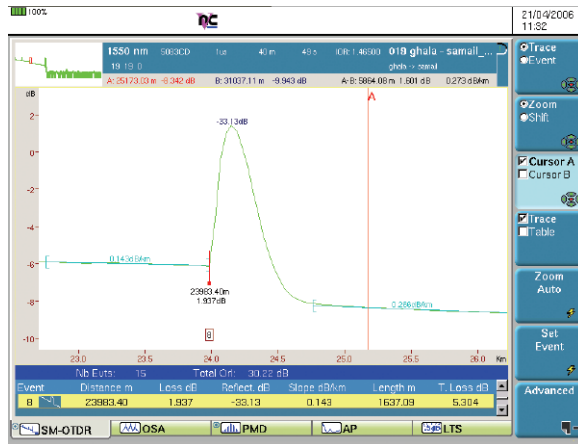

Reflectance measurement

The amount of reflection at a connector, break, or mechanical splice depends on the difference in the refractive index between the fiber and the material at the fiber interface (another fiber, air, or index-matching gel) and the geometry of the break or connector (flat, angled, or crushed). Both of these factors allow for the capture of a different amount of reflection by in the fiber core.

Most mechanical splices use an index-matching gel or fluid to reduce the difference in the refractive indexes. Smaller differences in the refractive index will produce smaller reflections. Some OTDRs can automatically measure the amount of reflecting light by placing one cursor just in front of the reflection, placing another cursor at the top of the reflection, and pressing the appropriate button on the control panel of the OTDR.

4.3.7 Optical Return Loss

High-performance OTDRs can automatically measure and report a value for the total link optical return loss (ORL). A manual ORL measurement capability is also provided in order to isolate the portion of the link, which contributes the majority of the ORL.

4.3.7.1 Measuring ORL with an OTDR

The light received by an OTDR corresponds to the behavior of the reflected power along the fiber link according to the injected pulsewidth. The integral of this power allows for the calculation of the total back reflection and for the determination of the ORL value.

$$ORL = 10 \text{ Log } [(P_o \times \Delta t) / (\int P_r(z) dz)]$$

Where P_o is the output power of the OTDR, Δt is the OTDR pulsewidth, and $\int P_r(z) dz$ is the total backreflected and backscattered power over the distance (partial or total).

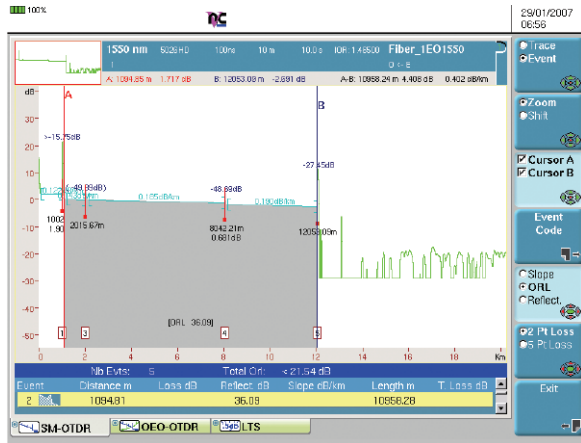

ORL measurement of a fiber link

In addition to providing a total link ORL result, the OTDR allows technicians to locate and measure backreflection points. It also allows technicians to perform partial ORL measurements (according to a given fiber section).

Total ORL Measurement

When performing an OTDR acquisition, total ORL is provided automatically. It includes the reflected light caused by connectors and termination fibers. In order to remove consideration of the front-end connector reflectance at the incident power level (A_0), the backscattered level (Pbs) is extrapolated to the distance origin.

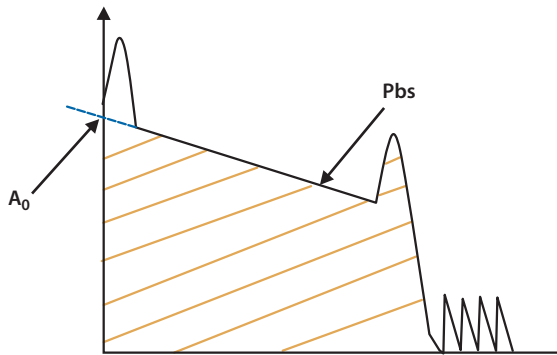

Total ORL measurement

Section ORL Measurement

It is also possible to measure ORL for a given section of the OTDR trace. Since the backscattered power level (P_{bs}) is known, the incident power A_0 at the starting point is referenced by the cursor.

1. Integration of the area between A_0 and A_i is performed, where A_i is the power level corresponding to the end of the ORL section located on the OTDR trace by the cursor 2.

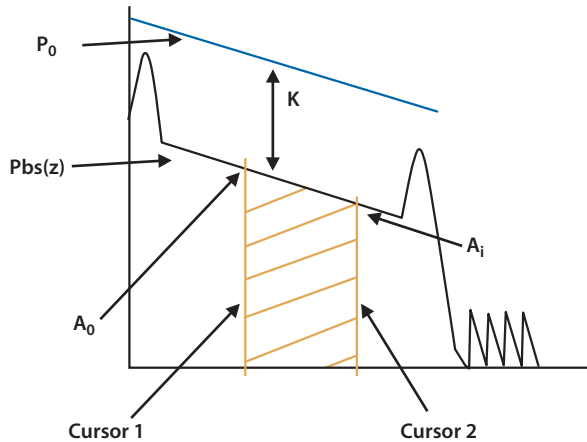

Section ORL measurement

4.4 Measurement Artifacts and Anomalies

Occasionally, unexpected results and events are displayed on the backscattered trace.

4.4.1 Ghosts

False Fresnel reflections, termed ghosts, on the trace waveform may be observed from time to time. Ghosts can be the result of a strong reflective event on the fiber, causing a large amount of reflected light to be sent back to the OTDR, or an incorrect range setting during acquisition.

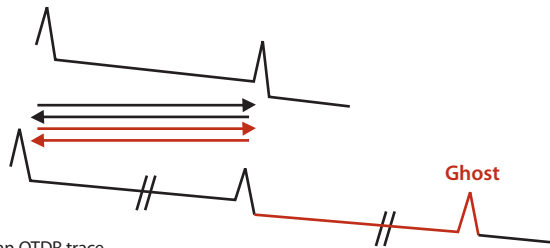

Ghosts on an OTDR trace

In both cases, the ghost can be identified since no loss is incurred as the signal passes through this event. In the first case, the distance that the ghost occurs along the trace is a multiple of the distance of the strong reflective event from the OTDR.

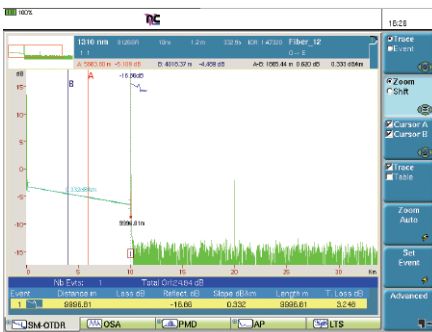

An example of a ghost in the signal noise



An example of a ghost on the OTDR trace

In order to reduce the reflection, index-matching gel can be used at the reflection point. In addition, the injected power can be reduced by selecting a shorter pulsewidth, selecting a reduced power setting on the OTDR (some OTDRs provide this option), or adding attenuation in the fiber before the reflection.

If the event causing the ghost is situated at the end of the fiber, a few short turns around a suitable tool (pen, pencil, mandrel, etc.) will sufficiently attenuate the amount of light being reflected back to the source and eliminate the ghost. This is known as a mandrel wrap.

Be sure to select a mandrel of the appropriate diameter for the type of cable, jacketed fiber, or coated fiber being used, eliminating permanent damage to the fiber span. It is never recommended to bend a fiber or cable in order to introduce attenuation without the use of a suitable mandrel, preventing excess bending.

4.4.2 Splice Gain

It is important to note that an OTDR measures splice loss indirectly, depending on information obtained from the backscattered signal. It is assumed that the backscattering coefficients of the fiber spans are identical all along the link under test. If this is not the case, then measurements can be inaccurate. One common example is the observance of apparent splice gains or gainers. The inaccuracy is quite small, but with today's fusion splicing equipment and experienced technicians making very low loss splices, it is possible for the effect to make the splice appear to be a gain instead of a loss.

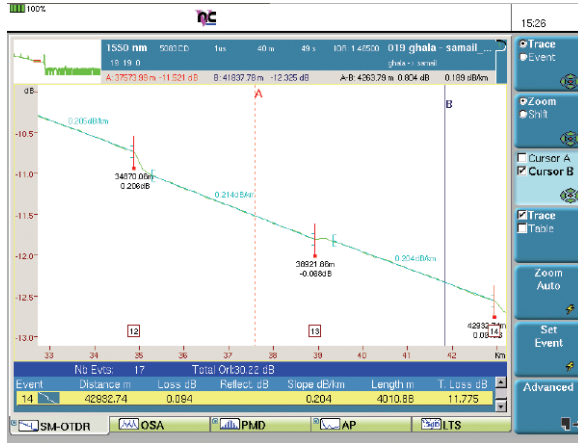

A splice gain on an OTDR trace

4.4.2.1 Splice Gain Theory

If fibers of different mode field diameters (core size, etc.) are joined, the resulting OTDR trace waveform can show a higher backscattering level. This is due to the increased level of backscattered signal reflected back to the OTDR in the downstream fiber.

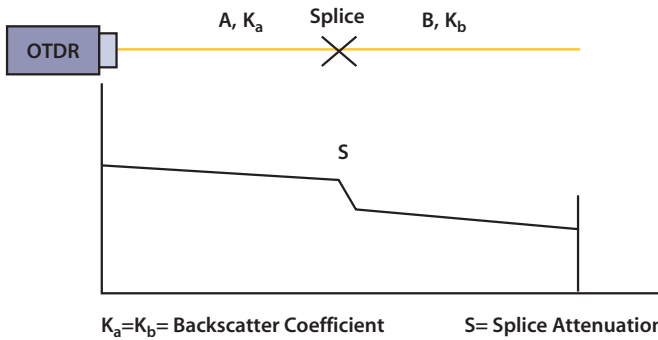

A normal splice

This phenomenon can occur when jointing different types of fiber in a multimode span or jointing two fibers with different backscatter coefficients.

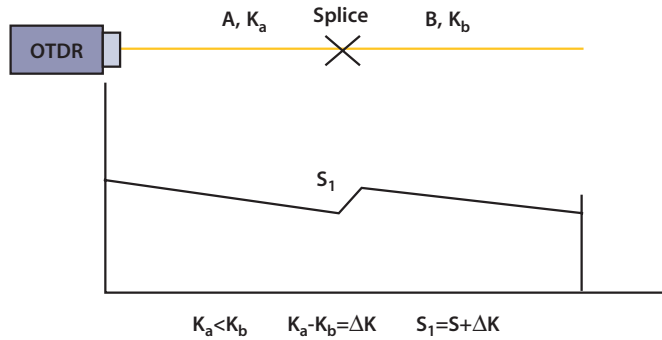

A positive splice from A to B

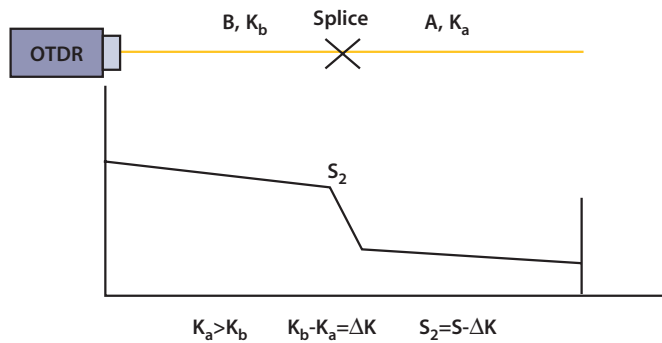

A negative splice from B to A

The bidirectional or average splice loss value (S) can be calculated:

$$S = \frac{S_1 + S_2}{2}$$

4.5 Bidirectional Analysis

It is a known fact that there is no such thing as a passive amplifier and that a gain in optical power cannot be obtained from a fusion splice, but the OTDR will sometimes report a gain caused by differences in the backscatter coefficient. While these backscatter coefficient differences will not always cause a gain on the OTDR trace, they can still cause erroneous splice loss readings even if the reading is a loss.

Bidirectional analysis is a technique that is used to minimize the effects of backscatter coefficient differences along a span, which cause these erroneous splice readings. Bidirectional analysis is used when very accurate baseline data on a span is desired, during acceptance testing, or when accurate measurement of splicing, often performed by subcontractors, is desired.

The concept of bidirectional analysis is as follows: If there is a backscatter coefficient mismatch between two spliced fibers, the algebraic sense of that difference will change depending on the direction of measurement. That is, if measured in one direction, the difference will appear as a gain. If measured in the opposite direction, the difference will appear as a loss. This difference will combine with the actual splice loss during measurement. However, if the splice loss reading taken in both directions is averaged, then the backscatter effect will subtract out, yielding the actual splice loss.

While the concept of bidirectional analysis is presented below in detail and the manual calculations are presented, in actuality, this analysis is usually performed using software applications, such as JDSU FiberTrace or FiberCable. These software applications automatically perform bidirectional analysis on more complex spans than shown here.

4.5.1 Bidirectional Analysis of a Hypothetical Span

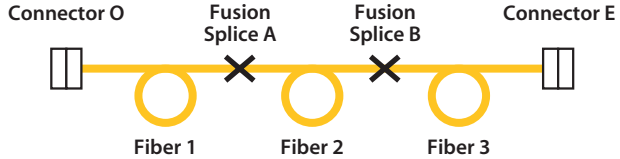

The span architecture

The hypothetical span is comprised of three fiber sections fusion spliced between connector O and connector E. The relative backscatter profile of the fibers is shown below. In this example, the loss in the fiber is temporarily ignored in order to show that if the backscatter coefficient is sampled at many points along the span, the coefficient will be higher in the second, or middle, section.



Backscatter profile of the span

For this example, the OTDR displays the effect of the backscatter mismatch as 0.05 dB. Note that the effect will appear as a gain if going into fiber 2, but it will appear as a loss if exiting fiber 2.

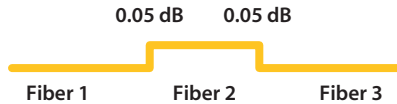

Apparent loss/gain at the junction due to the backscatter coefficient difference

This span has been fusion spliced, and the actual fusion splice loss is -0.03 dB at splice A between fibers 1 and 2 and -0.07 dB at splice B between fibers 2 and 3. For this discussion, a minus sign represents a loss and no sign represents a gain.

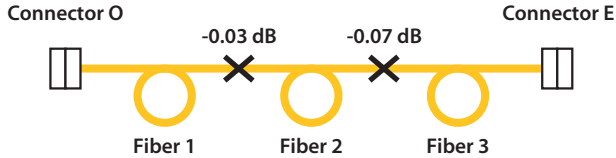

Actual fusion splice loss

The following diagram shows what the OTDR reads:

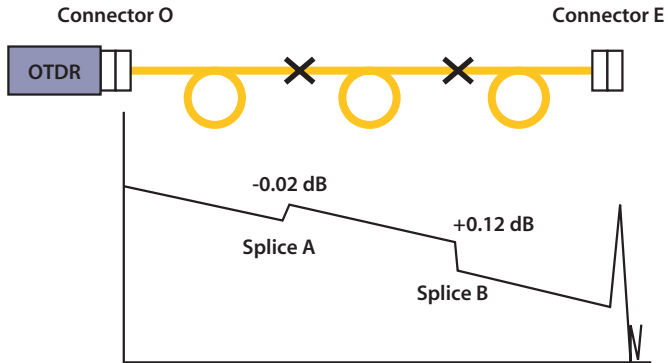

OTDR measurement from connector O to connector E (O -> E)

When measuring from connector O to connector E with the fiber loss now shown, splice A appears to be a gain of 0.02 dB (the actual -0.03 dB loss plus the apparent 0.05 dB gain due to backscatter). Splice B appears to be a -0.12 dB loss (the actual -0.07 dB loss plus the apparent -0.05 dB loss due to backscatter).

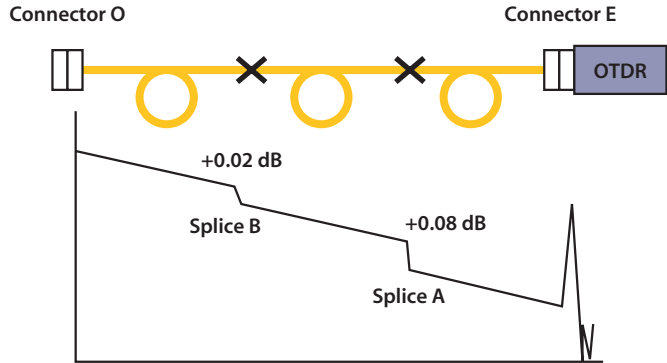

OTDR measurement from connector E to connector O (E -> O)

The measurement is then repeated for the opposite direction (from connector E to connector O). Remember that splice B is now on the left side of the OTDR trace, and splice A is on the right side of the OTDR trace. In this case, splice A appears to be a loss of 0.08 dB (the actual 0.03 dB loss plus the apparent 0.05 dB loss due to backscatter), and splice B appears to be a 0.02 dB loss (the actual 0.07 dB loss plus the apparent 0.05 dB gain due to backscatter).

After performing the two measurements, a simple chart is generated, showing the loss and gain of splices A and B in each direction. The two readings are added together, and the sum is divided by two in order to determine the average (actual) loss.

	OTDR				Actual Loss
	O->E	E->O	Sum	Average	
Splice A	-0.02	0.08	0.06	0.03	0.03
Splice B	0.12	0.02	0.14	0.07	0.07

Bidirectional analysis table

The results from the table now accurately represent the actual splice losses of the two events.

4.6 Getting the Most Out of Your OTDR

4.6.1 Using Launch Cables

4.6.1.1 Acceptance Testing Without the Use of Launch and Receive Cables

The OTDR enables technicians to qualify components between both ends of a fiber link. However, neither the front end connector nor the far end connector can be qualified when the OTDR is directly connected to the link at the front end and nothing is connected at the far end. In this case, a reference backscattered signal is not available. Therefore, loss measurements at the end connector points cannot be determined.

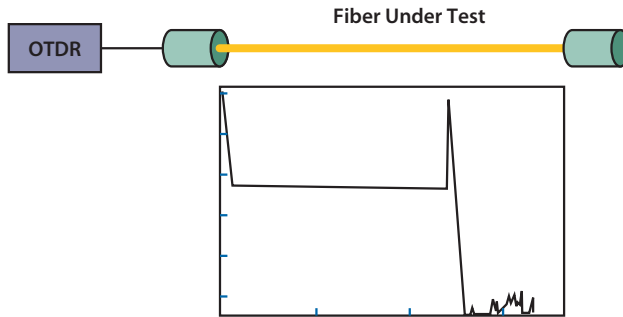

Acceptance testing without the use of launch and receive cables

In order to alleviate this problem, a section of cable is added at the OTDR launch location (front end) and at the receive location (far end) of the fiber under test.

4.6.1.2 Acceptance Testing Using Launch and Receive Cables

Launch and receive cables, consisting of a spool of fiber with a specific distance, can be connected to both ends of the fiber link under test in order to qualify the front end and far end connectors using an OTDR. The length of the launch and receive cables depends on the link being tested, but it is generally between 300 and 500 m for multimode testing and between 1000 m and 2000 m for singlemode testing. For very long-haul fiber links, 4000 m of

cable may be used. The fiber length is highly dependent on the OTDR attenuation dead zone, which is a function of the pulsewidth. The larger the pulsewidth, the longer the launch and receive cables.

In order to qualify the front end and far end connectors, the launch cable is connected between the OTDR and the fiber under test, and the receive cable is connected at the far end of the fiber link. The OTDR then characterizes the link including the launch and receive cables. Due to the additional fiber spools, a backscattered signal is measured from both sides of the end connectors, allowing for loss and reflectance measurement of the front end and far end connectors. Therefore, the fiber link under test, as well as all of its components, is correctly qualified.

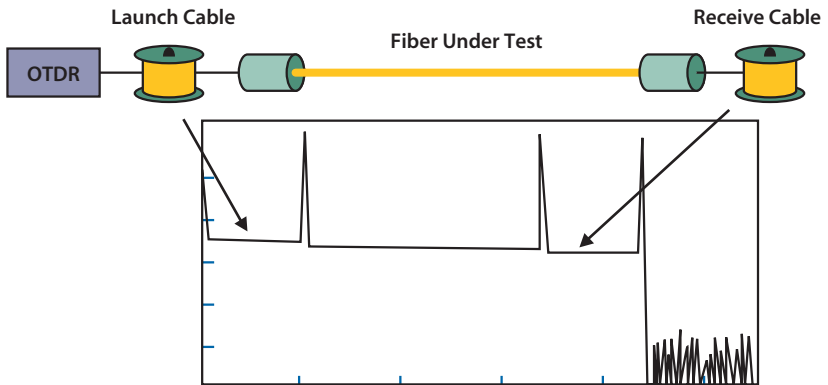

Acceptance testing using launch and receive cables

It is important to note that the fiber used in the launch and receive cable should match the fiber being tested (type, core size, etc.) In addition, the cable connectors should be of high quality.

The use of launch and receive cables in OTDR measurement allows for a number of effective tasks including:

- Correct measurement of the insertion loss of the link's far end connectors

- Shifts the dead zone, caused by the OTDR front end connector, outside of the trace from the link under test
- Improves modal equilibrium characteristics in multimode systems so that measurements are more precise
- Allows technicians to control the OTDR injection level into the link under test

4.6.2 Verifying Continuity

Sometimes a multi-fiber cable is installed and the technician needs to verify that the cable is continuous between the two exposed ends. An OTDR measurement can be performed on the cable in each direction, confirming continuity. An OTDR measurement in one direction can be performed in order to determine the length of the cable as represented by the trace. However, the length of each fiber in the cable often varies by a few meters due to the slightly different buffer tube over lengths or the helix geometry of the fibers within the cable. It is difficult, if not impossible, to distinguish a fiber with a much lower over length from a broken fiber inside the cable, which is one meter from the far end.

An easier way to verify continuity, without having to perform a complete OTDR test from both ends, can be accomplished as follows. In this case, either access to both ends of the cable is required or two technicians, with a communication capability between the two technicians, are required.

The OTDR is connected to one of the fibers in the cable (fiber 1). The OTDR is set to Real Time mode, and the end of the resulting trace is observed. If the length is grossly short, then it is broken. If the length looks approximately correct, then the following steps are performed:

- If an end spike is not visible, indicating a reflective event at the non-terminated glass/air interface at the end of the cable, then one technician cleaves the fiber end squarely with a hand cleaver. The end spike or end reflection should become apparent. If it does not become apparent, the technician is not holding the end

of fiber 1. Fiber 1 must be broken somewhere inside the cable near the end.

- If, at first, a large end spike is visible, the technician dips the end of the fiber in index-matching gel or alcohol or wraps the fiber around a small mandrel near the end. Doing any of these tasks will attenuate the end spike. If it does not, then the fiber is broken somewhere else near the end of the cable.

4.6.3 Fault Location

The OTDR can be an invaluable tool for fault location. Accurate fault location depends on careful measurement techniques using the OTDR and on complete and accurate system (cable) documentation. While entire courses are often taught on the subject of fault location, following the few recommendations discussed below may make the process more accurate and efficient.

Cable breaks can be partial or complete (catastrophic). The most common cause of cable breaks is a dig-up. Over 40% of all breaks are caused by an inadvertent dig-up. In the case of a dig-up, fault location does not need to be extremely precise since the damage can usually be easily located once the technician is near the break. Other types of breaks, including ballistic (from hunting weapons) or rodent damage, are more difficult to find, and accurate location with an OTDR can save a great deal of time and money.

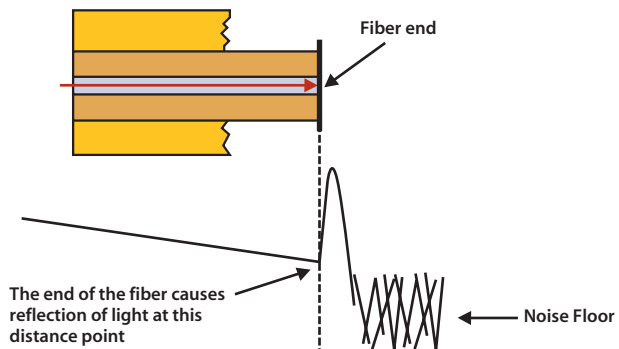

Break or fiber end location

When a cable is damaged, the resulting break may be highly reflective or non-reflective. It is generally much easier to determine an accurate distance to a reflective break. Therefore, it is sometimes helpful to measure several broken fibers until a reflective break is detected. If the break is non-reflective, it is usually best to let the OTDR's software determine the distance to the event using automatic analysis. This is because placing a marker visually can be inaccurate.

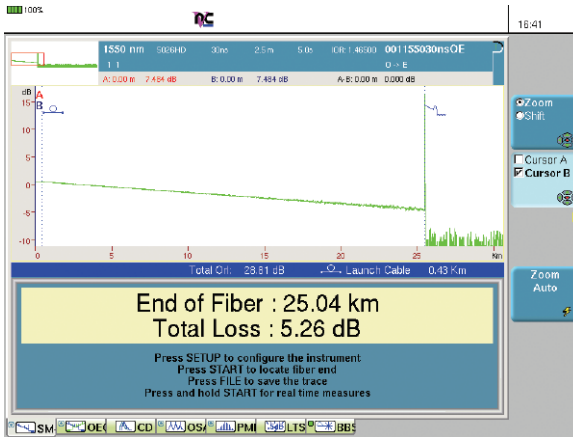

Fault location using an OTDR

In this case, the technician may want to calibrate the OTDR to display distance in cable or sheath distance by using an effective refractive index. While the OTDR can accurately determine distances to 5 meters in a 10,000 meter span, the helix factor of the cable can contribute up to 600 meters of inaccuracy over the span.

An alternate method of determining actual distance from optical distance is to measure the break from both end points and determine the position of the break relative to the total span length. This ratio of the optical distance to the break to the

total optical length of the span will be the same as the ratio of the sheath distance to the break to the total sheath length.

It is important to remember the locations where cable slack is stored. If the OTDR reads 1800 meters to a break, but there are 200 meters of cable slack stored at an intermediate hand hole, manhole, or pole, then the distance to the break will be similarly shorter.

It is also important to remember that sagging in aerial plant sheath distance will differ somewhat from pole distance. After the location of the break is determined, it should be correlated to a cable sequential marking. Then, when excavating the cable or examining the aerial plant with binoculars, the correct section of cable can be confirmed quickly.

It is always best to measure the distance to the break from the last event whose physical location is known on the OTDR trace using the cursors. In this manner, the shortest possible measurement is performed by the OTDR, reducing the OTDR's contribution to measurement inaccuracy.

4.6.4 Effective Refractive Index

The OTDR determines the distance to the event based on time. The refractive index serves as a correlation factor between time and distance, allowing the OTDR to display distance accurately.

If the refractive index provided by the fiber manufacturer is known, the technician can set this value on the OTDR, thus improving the accuracy of the displayed optical distance.

In most cable designs, the length of the fiber is greater than the length of the cable. This can be caused by fiber over length in the buffer tubes (in loose buffer designs) or helixing of the buffer tubes or ribbons inside the cable. Therefore, the cable length or physical distance can vary significantly from the fiber length or optical distance.

In some cases, notably fault location, technicians may want the OTDR to display cable or physical distance instead of optical distance. This can be accomplished by using a different value for the refractive index. This is sometimes termed the effective refractive index, which is adjusted for fiber over length.

There are two ways to determine the effective refractive index.

1. Using cable records or knowing the cable or physical distance (L_{eff}) between two known events on the OTDR trace, the technician obtains the following data from the OTDR:
 - Optical distance between two known events (L_{opt})
 - Refractive index used by the instrument (RI_{opt})

The effective refractive index (RI_{eff}) can then be calculated using the formula:

$$RI_{\text{eff}} = (L_{\text{opt}} \times RI_{\text{opt}}) / L_{\text{eff}}$$

2. Using some OTDRs, such as the JDSU T-BERD/MTS platforms, RI_{eff} can be calculated automatically by delimiting the two known events with two cursors and changing the refractive index until the OTDR reports cable or physical distance instead of optical distance.

During initial cable documentation, it is recommended to use the OTDR features that permit the addition of notes to events or files. Geographic or GPS data can be entered that will be very useful during fault location. Again, there is absolutely no substitute for complete, detailed, accurate cable documentation records during fault location.

4.6.5 Automating Bidirectional Analysis

Testing time increases with the number of fibers. In order to expedite the installation phase or increase the number of fibers tested within a given time period, the importance of having fully automatic tools, such as an automatic bidirectional OTDR tester, becomes clear.

The automatic bidirectional OTDR function solves the problems of traditional bidirectional OTDR analysis. An automatic solution provides the following capabilities:

- Performs a fiber continuity check to ensure that both units are testing the same fiber
- Provides error-free operation by exchanging the master unit's OTDR test configuration if it differs from the slave unit's OTDR test configuration
- Performs data acquisition on the slave unit and transfers the trace to the master unit
- Performs data acquisition on the master unit and transfers the trace to the slave unit
- Performs bidirectional measurements on both units
- Stores results in a single file or in two files

The bidirectional analysis procedure is fully automatic, and all of the test results are immediately accessible on both units. In addition, unprecedented data acquisition speeds and fully automatic bidirectional capabilities significantly reduce test times.

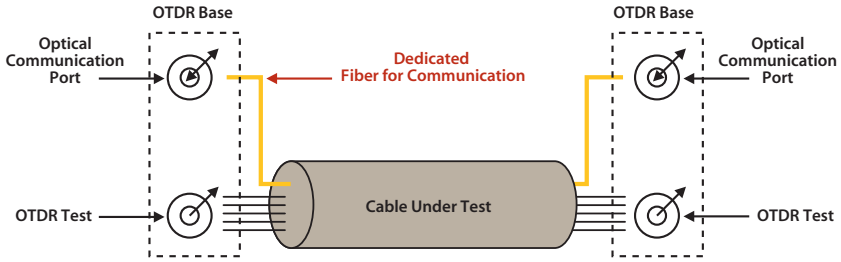

Automatic bidirectional OTDR measurement configuration

4.6.6 Loopback Measurement Method

Using the loopback method, technicians need only one OTDR for bidirectional OTDR measurement. The OTDR data acquisitions are performed at one end of the fiber (the near end). Since two fibers are measured with one acquisition, the data acquisition time is reduced by a factor of two. One technician is required at the near-end OTDR location while the other technician, located at the far end of the link, loops the fiber path with a splice, patchcord, or launch lead.

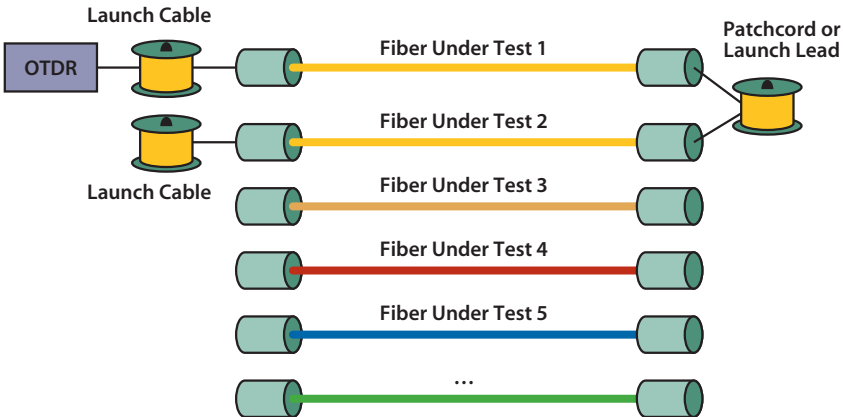

A loopback measurement, measuring O->E of fiber 1 and E->O of fiber 2

Since the end customer of the cable is not interested in the test method but more in the precise loss results (without the fiber loops), the splice point, patchcord, or launch lead, is eliminated from the result tables so that the report contains only the cable data.

4.7 OTDR Acceptance Reporting Tool

Data collected in the field for analysis must be organized in order to generate the acceptance report. The acceptance report provides the end customer with an easy-to-read professional report and documents the characteristics of the fiber. Technicians organize the results into dedicated tables, including cable and job information, section length, bidirectional splice loss, end connector reflectance, insertion loss, end-to-end loss, wavelength loss comparison, and out-of-range loss values.

The OTDR report generation process requires four steps: results analysis, results conditioning, report generation, and document printout.

4.7.1 Results Analysis

Test results are downloaded and organized in the office computer. With direct access to the OTDR traces, the acceptance reporting software automatically combines the O->E and E->O traces for each fiber at each wavelength.

The technician follows a simple trace information convention using the same cable ID and fiber numbers. O->E indicates one direction. E->O indicates the other direction. On one screen, the technician has access to all of the bidirectional analysis data that was collected on the fibers for the entire cable.



Measurement report

File Report Macro Options Remote Window ?

OTDR PMD CD Preview

Trace directory: C:\Documents and Settings\karel\My documents\2_Product

File	Cable	Fiber	Way	Wavelength	State	Fiber	Cable	Wavelength	O.S.E	O.C.E	O.c.MP	MP>E
ul1013jo...	NCODIA	1	D->E	1310	OK	1	NCODIA	1310	ul013jo.fhw		ul013jo.fhw	
ul1012jo...	NCODIA	1	D<-E	1310	Distance spacing: 2	2	NCODIA	1310	ul023jo.fhw		ul023jo.fhw	
ul1023jo...	NCODIA	2	O->E	1310	Different number o...	4	NCODIA	1310	ul043jo.fhw		ul043jo.fhw	
ul1022jo...	NCODIA	2	D<-E	1310	Different number o...	5	NCODIA	1310	ul053jo.fhw		ul053jo.fhw	
ul1033jo...	NCODIA	3	O->E	1310	Different number o...	6	NCODIA	1310	ul063jo.fhw		ul063jo.fhw	
ul1032jo...	NCODIA	3	D<-E	1310	Different number o...	7	NCODIA	1310	ul073jo.fhw		ul073jo.fhw	
ul1043jo...	NCODIA	4	O->E	1310	Different number o...	8	NCODIA	1310	ul083jo.fhw		ul083jo.fhw	
ul1053jo...	NCODIA	4	D<-E	1310	Different number o...	9	NCODIA	1310	ul093jo.fhw		ul093jo.fhw	
ul1052jo...	NCODIA	5	O->E	1310	Different number o...	10	NCODIA	1310	ul103jo.fhw		ul103jo.fhw	
ul1053jo...	NCODIA	5	D<-E	1310	Different number o...	11	NCODIA	1310	ul113jo.fhw		ul113jo.fhw	
ul1053jo...	NCODIA	6	O->E	1310	Distance spacing: 1...	12	NCODIA	1310	ul123jo.fhw		ul123jo.fhw	
ul1053jo...	NCODIA	6	D<-E	1310	Distance spacing: 1...	13	NCODIA	1310	ul133jo.fhw		ul133jo.fhw	
ul1073jo...	NCODIA	7	O->E	1310	Distance spacing: 1...	14	NCODIA	1310	ul143jo.fhw		ul143jo.fhw	
ul1073jo...	NCODIA	7	D<-E	1310	Distance spacing: 1...	15	NCODIA	1310	ul153jo.fhw		ul153jo.fhw	
ul1083jo...	NCODIA	8	O->E	1310	Different number o...	16	NCODIA	1310	ul163jo.fhw		ul163jo.fhw	
ul1083jo...	NCODIA	8	D<-E	1310	Different number o...	17	NCODIA	1310	ul173jo.fhw		ul173jo.fhw	
ul1083jo...	NCODIA	8	D<-E	1310	Different number o...	18	NCODIA	1310	ul183jo.fhw		ul183jo.fhw	
ul1093jo...	NCODIA	9	O->E	1310	Different number o...	19	NCODIA	1310	ul193jo.fhw		ul193jo.fhw	
ul1093jo...	NCODIA	9	D<-E	1310	Distance spacing: 1...	20	NCODIA	1310	ul203jo.fhw		ul203jo.fhw	
ul1103jo...	NCODIA	10	O->E	1310	Different number o...	21	NCODIA	1310	ul213jo.fhw		ul213jo.fhw	
ul1103jo...	NCODIA	10	D<-E	1310	Distance spacing: 1...	22	NCODIA	1310	ul223jo.fhw		ul223jo.fhw	
ul1113jo...	NCODIA	11	O->E	1310	Different number o...	23	NCODIA	1310	ul233jo.fhw		ul233jo.fhw	
ul1113jo...	NCODIA	11	D<-E	1310	Different number o...	24	NCODIA	1310	ul243jo.fhw		ul243jo.fhw	
ul1123jo...	NCODIA	12	O->E	1310	Different number o...	25	NCODIA	1310	ul253jo.fhw		ul253jo.fhw	
ul1123jo...	NCODIA	12	D<-E	1310	Different number o...	26	NCODIA	1310	ul263jo.fhw		ul263jo.fhw	
ul1133jo...	NCODIA	13	O->E	1310	Different number o...	27	NCODIA	1310	ul273jo.fhw		ul273jo.fhw	
ul1133jo...	NCODIA	13	D<-E	1310	Different number o...	28	NCODIA	1310	ul283jo.fhw		ul283jo.fhw	
ul1133jo...	NCODIA	13	D<-E	1310	Different number o...	29	NCODIA	1310	ul293jo.fhw		ul293jo.fhw	

Test results management using JDSU FiberCable software

Using the data from the OTDR traces in both directions, event locations can be adjusted on the fiber creating a template.

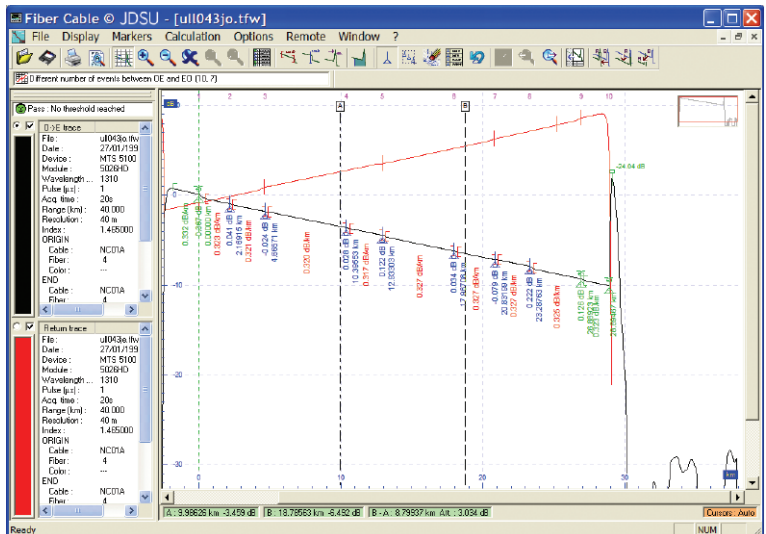

Bidirectional analysis using JDSU FiberCable software

This template is then used as a reference for all the other fibers in the cable, thus ensuring that the splice points are correctly located and recorded for the entire cable. An update of the bidirectional analysis status prevents incorrect results.

File	Cable	Fiber	Why	Wavelength	State	Fiber	Cable	Wavelength	O->E	O<-E	O<-MP	MP->E
ul013j...	NC01A	1	O->E	1310	OK	1	NC01A	1310	ul013j #w	ul013j #w		
ul013j...	NC01A	1	O<-E	1310	OK	2	NC01A	1310	ul023j #w	ul023j #w		
ul023j...	NC01A	2	O->E	1310	OK	3	NC01A	1310	ul033j #w	ul033j #w		
ul023j...	NC01A	2	O<-E	1310	OK	4	NC01A	1310	ul043j #w	ul043j #w		
ul033j...	NC01A	3	O->E	1310	OK	5	NC01A	1310	ul053j #w	ul053j #w		
ul033j...	NC01A	3	O<-E	1310	OK	6	NC01A	1310	ul063j #w	ul063j #w		
ul043j...	NC01A	4	O->E	1310	OK	7	NC01A	1310	ul073j #w	ul073j #w		
ul043j...	NC01A	4	O<-E	1310	OK	8	NC01A	1310	ul083j #w	ul083j #w		
ul053j...	NC01A	5	O->E	1310	OK	9	NC01A	1310	ul093j #w	ul093j #w		
ul053j...	NC01A	5	O<-E	1310	OK	10	NC01A	1310	ul103j #w	ul103j #w		
ul063j...	NC01A	6	O->E	1310	OK	11	NC01A	1310	ul113j #w	ul113j #w		
ul063j...	NC01A	6	O<-E	1310	OK	12	NC01A	1310	ul123j #w	ul123j #w		
ul073j...	NC01A	7	O->E	1310	OK	13	NC01A	1310	ul133j #w	ul133j #w		
ul073j...	NC01A	7	O<-E	1310	OK	14	NC01A	1310	ul143j #w	ul143j #w		
ul083j...	NC01A	8	O->E	1310	OK	15	NC01A	1310	ul153j #w	ul153j #w		
ul083j...	NC01A	8	O<-E	1310	OK	16	NC01A	1310	ul163j #w	ul163j #w		
ul093j...	NC01A	9	O->E	1310	OK	17	NC01A	1310	ul173j #w	ul173j #w		
ul093j...	NC01A	9	O<-E	1310	OK	18	NC01A	1310	ul183j #w	ul183j #w		
ul103j...	NC01A	10	O->E	1310	OK	19	NC01A	1310	ul193j #w	ul193j #w		
ul103j...	NC01A	10	O<-E	1310	OK	20	NC01A	1310	ul203j #w	ul203j #w		
ul113j...	NC01A	11	O->E	1310	OK	21	NC01A	1310	ul213j #w	ul213j #w		
ul113j...	NC01A	11	O<-E	1310	OK	22	NC01A	1310	ul223j #w	ul223j #w		
ul123j...	NC01A	12	O->E	1310	OK	23	NC01A	1310	ul233j #w	ul233j #w		
ul123j...	NC01A	12	O<-E	1310	OK	24	NC01A	1310	ul243j #w	ul243j #w		
ul133j...	NC01A	13	O->E	1310	OK	25	NC01A	1310	ul253j #w	ul253j #w		
ul133j...	NC01A	13	O<-E	1310	OK	26	NC01A	1310	ul263j #w	ul263j #w		
ul133j...	NC01A	13	O->E	1310	OK	27	NC01A	1310	ul273j #w	ul273j #w		
ul133j...	NC01A	13	O<-E	1310	OK	28	NC01A	1310	ul283j #w	ul283j #w		
ul133j...	NC01A	13	O->E	1310	OK	29	NC01A	1310	ul293j #w	ul293j #w		
ul133j...	NC01A	13	O<-E	1310	OK							

The template is applied to all the fibers using JDSU FiberCable software

The technician may want to include textual information, for fault finding and cable restoration purposes, along with the fiber template. Each event can be identified with a descriptor (manhole, water crossing, bridge, GPS coordinates, or other physical landmark) for identification. This information only needs to be entered once into the template. It can then be copied to all of the other fibers in the cable.

4.7.2 Results Conditioning

When all of the fibers are complete with their bidirectional test data at both or multiple wavelengths, they must be compiled into cable

records. Using the traditional method, this operation was the longest in the process since all of the data needed to be exported into a spreadsheet and formatted into a table.

With such a large amount of test data for processing, it is important to verify the results before running the report. A report preview function may be available. This function is useful in displaying the individual fiber data compiled into table format. The technician can then step through each fiber, display the OTDR traces and the table of events, and preview the data entry in spreadsheet format.

ID	Cable	ID Fibre	Wavelength	Average	1: O-->	1: E-->X	1: Average	2: O-->	2: E-->X	2: Average	3: O-->	3: E-->X	3: Average	4: O-->	4: E-->X	4: Average
1	NC...	1	1310	0.033	0.256	-0.041	0.107	0.013	0.018	0.015	0.056	-0.003	0.026	0.046	0.028	0.0
2	NC...	2	1310	0.021	0.285	0.028	0.157	0.019	0.012	0.015	0.035	0.029	0.032	0.026	0.026	0.0
3	NC...	3	1310	0.027	0.331	-0.012	0.159	0.010	0.010	0.010	-0.010	0.035	0.012	0.016	0.038	0.0
4	NC...	4	1310	0.031	0.365	-0.059	0.153	0.038	0.012	0.025	-0.026	0.188	0.081	0.003	0.001	0.0
5	NC...	5	1310	0.023	0.184	0.103	0.143	0.046	0.050	0.048	0.171	-0.125	0.023	0.007	0.006	0.0
6	NC...	6	1310	0.045	0.376	-0.157	0.110	0.047	0.035	0.041	-0.041	0.071	0.015	0.072	0.085	0.0
7	NC...	7	1310	0.031	0.137	-0.010	0.063	0.007	0.018	0.012	0.073	-0.038	0.018	0.028	0.053	0.0
8	NC...	8	1310	0.026	0.473	-0.004	0.234	-0.010	-0.003	-0.007	-0.081	0.106	0.012	0.123	0.125	0.1
9	NC...	9	1310	0.015	0.238	-0.015	0.112	0.013	0.013	0.013	0.046	0.025	0.035	0.031	0.043	0.0
10	NC...	10	1310	0.023	0.469	0.228	0.348	0.016	0.021	0.018	0.004	0.025	0.015	-0.004	0.026	0.0
11	NC...	11	1310	0.031	0.384	0.121	0.252	0.043	0.040	0.041	0.071	-0.031	0.020	0.026	0.022	0.0
12	NC...	12	1310	0.028	0.372	-0.050	0.161	0.065	0.059	0.062	-0.081	0.082	0.001	0.062	0.059	0.0
13	NC...	13	1310	0.028	0.317	0.032	0.175	0.085	0.079	0.082	-0.054	0.071	0.008	0.107	-0.038	0.0
14	NC...	14	1310	0.025	0.372	0.101	0.237	0.009	0.016	0.012	0.035	0.009	0.020	-0.041	0.047	0.0
15	NC...	15	1310	0.023	0.550	0.169	0.359	-0.009	0.006	-0.001	-0.003	0.047	0.022	-0.018	0.037	0.0
16	NC...	16	1310	0.026	0.400	-0.025	0.187	0.018	0.016	0.017	-0.015	0.076	0.031	-0.018	0.050	0.0
17	NC...	17	1310	0.023	0.134	0.069	0.101	0.024	0.038	0.031	0.100	-0.025	0.037	0.106	-0.073	0.0
18	NC...	18	1310	0.024	0.407	-0.153	0.127	0.082	0.071	0.076	-0.129	0.193	0.032	-0.015	0.098	0.0
19	NC...	19	1310	0.033	0.381	0.237	0.309	-0.003	0.021	0.009	0.131	-0.047	0.042	0.053	0.019	0.0
20	NC...	20	1310	0.022	0.470	-0.019	0.226	-0.007	-0.001	-0.004	-0.049	0.115	0.033	0.088	-0.009	0.0
21	NC...	21	1310	0.011	0.366	0.112	0.239	-0.001	0.003	0.001	0.056	-0.010	0.023	0.047	-0.046	0.0

Report preview using JDSU FiberCable software

4.7.3 Report Generation

Once the results have been compiled, previewed, and verified against specific criteria, the next step is to generate the report using a spreadsheet program. The technician selects the different tables that are required for the acceptance report.

- Cable and job information
- Section length
- Bidirectional splice loss
- End connector reflectance and insertion loss
- End-to-end loss
- Insertion loss (with a loss test set)
- Optical return loss (with a loss test set)
- 1310/1550 nm loss comparison
- Out-of-range loss values

4.7.4 Document Printout

Although the data produced at this stage is complete, more work is needed to transform the results into a professional-looking cable report.

Loss comparison tables between wavelengths and out-of-range loss values summary tables can be used to identify and point out potential problems during installation, either through mechanical stress (1310/1550 nm loss comparison) or through non-conformity to the cable acceptance criteria.

At this point, the technician can add information and comments regarding the cable, fiber, and test parameters before printing the final document. This level of document customization provides the technician with the ability to better report the data to the end customer.

Slope table at 155km: (dB km)

Elev. Rank	Stage 1		Stage 2		Stage 3		Stage 4		Stage 5		Stage 6		Stage 7		Stage 8		Stage 9	
	GC	Aug	GC	Aug	GC	Aug	GC	Aug	GC	Aug	GC	Aug	GC	Aug	GC	Aug	GC	Aug
1	0.21	0.19	0.14	0.14	0.14	0.14	0.21	0.21	0.21	0.18	0.21	0.18	0.21	0.21	0.21	0.21	0.21	0.21
2	0.30	0.18	0.15	0.20	0.15	0.23	0.15	0.15	0.23	0.15	0.18	0.42	0.20	0.18	0.15	0.20	0.18	0.20
3	0.19	0.19	0.25	0.20	0.25	0.25	0.25	0.20	0.20	0.19	0.19	0.42	0.19	0.18	0.19	0.20	0.19	0.20
4	0.19	0.19	0.25	0.20	0.18	0.18	0.20	0.18	0.18	0.18	0.18	0.18	0.18	0.18	0.18	0.18	0.18	0.18
5	0.19	0.19	0.25	0.20	0.18	0.18	0.20	0.18	0.18	0.18	0.18	0.18	0.18	0.18	0.18	0.18	0.18	0.18
6	0.19	0.19	0.25	0.20	0.18	0.18	0.20	0.18	0.18	0.18	0.18	0.18	0.18	0.18	0.18	0.18	0.18	0.18
7	0.19	0.19	0.25	0.20	0.18	0.18	0.20	0.18	0.18	0.18	0.18	0.18	0.18	0.18	0.18	0.18	0.18	0.18
8	0.19	0.19	0.25	0.20	0.18	0.18	0.20	0.18	0.18	0.18	0.18	0.18	0.18	0.18	0.18	0.18	0.18	0.18
9	0.19	0.19	0.25	0.20	0.18	0.18	0.20	0.18	0.18	0.18	0.18	0.18	0.18	0.18	0.18	0.18	0.18	0.18
10	0.19	0.19	0.25	0.20	0.18	0.18	0.20	0.18	0.18	0.18	0.18	0.18	0.18	0.18	0.18	0.18	0.18	0.18
11	0.19	0.19	0.25	0.20	0.18	0.18	0.20	0.18	0.18	0.18	0.18	0.18	0.18	0.18	0.18	0.18	0.18	0.18
12	0.19	0.19	0.25	0.20	0.18	0.18	0.20	0.18	0.18	0.18	0.18	0.18	0.18	0.18	0.18	0.18	0.18	0.18
13	0.19	0.19	0.25	0.20	0.18	0.18	0.20	0.18	0.18	0.18	0.18	0.18	0.18	0.18	0.18	0.18	0.18	0.18
14	0.19	0.19	0.25	0.20	0.18	0.18	0.20	0.18	0.18	0.18	0.18	0.18	0.18	0.18	0.18	0.18	0.18	0.18
15	0.19	0.19	0.25	0.20	0.18	0.18	0.20	0.18	0.18	0.18	0.18	0.18	0.18	0.18	0.18	0.18	0.18	0.18
16	0.19	0.19	0.25	0.20	0.18	0.18	0.20	0.18	0.18	0.18	0.18	0.18	0.18	0.18	0.18	0.18	0.18	0.18
17	0.19	0.19	0.25	0.20	0.18	0.18	0.20	0.18	0.18	0.18	0.18	0.18	0.18	0.18	0.18	0.18	0.18	0.18
18	0.19	0.19	0.25	0.20	0.18	0.18	0.20	0.18	0.18	0.18	0.18	0.18	0.18	0.18	0.18	0.18	0.18	0.18
19	0.19	0.19	0.25	0.20	0.18	0.18	0.20	0.18	0.18	0.18	0.18	0.18	0.18	0.18	0.18	0.18	0.18	0.18
20	0.19	0.19	0.25	0.20	0.18	0.18	0.20	0.18	0.18	0.18	0.18	0.18	0.18	0.18	0.18	0.18	0.18	0.18
21	0.19	0.19	0.25	0.20	0.18	0.18	0.20	0.18	0.18	0.18	0.18	0.18	0.18	0.18	0.18	0.18	0.18	0.18
22	0.19	0.19	0.25	0.20	0.18	0.18	0.20	0.18	0.18	0.18	0.18	0.18	0.18	0.18	0.18	0.18	0.18	0.18
23	0.19	0.19	0.25	0.20	0.18	0.18	0.20	0.18	0.18	0.18	0.18	0.18	0.18	0.18	0.18	0.18	0.18	0.18
24	0.19	0.19	0.25	0.20	0.18	0.18	0.20	0.18	0.18	0.18	0.18	0.18	0.18	0.18	0.18	0.18	0.18	0.18
25	0.19	0.19	0.25	0.20	0.18	0.18	0.20	0.18	0.18	0.18	0.18	0.18	0.18	0.18	0.18	0.18	0.18	0.18
26	0.19	0.19	0.25	0.20	0.18	0.18	0.20	0.18	0.18	0.18	0.18	0.18	0.18	0.18	0.18	0.18	0.18	0.18
27	0.19	0.19	0.25	0.20	0.18	0.18	0.20	0.18	0.18	0.18	0.18	0.18	0.18	0.18	0.18	0.18	0.18	0.18
28	0.19	0.19	0.25	0.20	0.18	0.18	0.20	0.18	0.18	0.18	0.18	0.18	0.18	0.18	0.18	0.18	0.18	0.18
29	0.19	0.19	0.25	0.20	0.18	0.18	0.20	0.18	0.18	0.18	0.18	0.18	0.18	0.18	0.18	0.18	0.18	0.18
30	0.19	0.19	0.25	0.20	0.18	0.18	0.20	0.18	0.18	0.18	0.18	0.18	0.18	0.18	0.18	0.18	0.18	0.18
31	0.19	0.19	0.25	0.20	0.18	0.18	0.20	0.18	0.18	0.18	0.18	0.18	0.18	0.18	0.18	0.18	0.18	0.18

Remarck

Page 1/17

A customized acceptance report

Notes:



Chromatic Dispersion Test and Measurement

All statements, technical information and recommendations related to the products herein are based upon information believed to be reliable or accurate. However, the accuracy or completeness thereof is not guaranteed, and no responsibility is assumed for any inaccuracies. The user assumes all risks and liability whatsoever in connection with the use of a product or its application. JDSU reserves the right to change at any time without notice the design, specifications, function, fit or form of its products described herein, including withdrawal at any time of a product offered for sale herein. JDSU makes no representations that the products herein are free from any intellectual property claims of others. Please contact JDSU for more information. JDSU and the JDSU logo are trademarks of JDS Uniphase Corporation. Other trademarks are the property of their respective holders.
©2007 JDS Uniphase Corporation. All rights reserved.



FO-GUIDE-VOL-1
Part # 21105787
Rev. 000
30149054.000.1206.FIBERGUIDE1.BK.FOP.TM.AE

Test & Measurement Regional Sales

North America	Latin America	Asia Pacific	EMEA	www.jdsu.com
Toll Free: 1 866 228 3762 Tel: +1 301 353 1560 x 2850 Fax: +1 301 353 9216	Tel: +55 11 5503 3800 Fax: +55 11 5505 1598	Tel: +852 2892 0990 Fax: +852 2892 0770	Tel.: +49 7121 86 2222 Fax: +49 7121 86 1222	